



Safety is for life.™

**REMBE®**  
**Process Safety**

Precise.  
Process optimised.  
Reliable.  
Sustainable.  
Authentic.  
Safe.

Reliable. German.  
Safety. ●●●

**Intelligent REMBE® high performance rupture discs protect life + plants and maximise efficiency + return.**



Since 1973, REMBE® has been one of the world market leaders in the field of pressure relief.

Our rupture discs are always individually manufactured to suit existing requirements depending on the respective process.

All our rupture discs are "Made in Germany". Because we know how important it is to get help quickly, we provide you with a product replacement within the shortest possible time with our RushOrder service:

We identify your rupture disc immediately and manufacture spare parts with the exact same specification. This way we enable you to quickly and cost-effectively resume your production without a long downtime. In addition to quality and reliability, we attach great importance to conformity with standards. Our rupture discs are certified according to the PED, ASME and a wide range of international standards. You can also trust our high product and service quality and experience how easy and cost-efficient it is to protect your processes with REMBE® rupture discs.

Stefan Penno  
Chief Executive Officer

06 | **Process Safety Basics.**

08 | **REMBE® RushOrder:** The fastest way to get your customised rupture disc.

## Reverse Acting Rupture Discs

12 | **KUB®** developed for your success.

14 | **KUB® clean** for applications with strict hygiene requirements.

15 | **KUB® V** for isolating safety valves.

16 | **KUB® F** for installation directly between flanges.

17 | **IKB®** the rupture disc with the patented manufacturing process.

## Forward Acting Rupture Discs

20 | **ODV** for low to medium pressures.

21 | **STAR** for low to high pressures.

22 | **SFD** for low to high pressures.

23 | **BT** for simple applications with medium to high pressures.

24 | **ZW** opens in one direction at defined overpressure + in the other direction at vacuum.

## Flat Rupture Discs

25 | For installation directly between flanges.

## Graphite rupture disc

26 | Extremely corrosive media, low pressures and high temperatures.

## Customised Compact Rupture Discs

30 | **UKB LS** maximum leak-tightness, also suitable for use in high vacuum.

31 | **Plug Type** the individual alternative.

32 | **HPRD** for high pressure + extreme temperatures.

33 | **Extruder rupture discs** for the plastics and food processing industries.

34 | **Combination rupture disc and safety valve.**

## + Accessories

# Rupture Disc Holder

- 38 | **Holder** for forward acting rupture discs.
- 39 | **PTU-Holder** for reverse acting rupture discs.
- 40 | **Double holder** for the use of two rupture discs installed in series.
- 41 | **Heated/Cooled holder** for applications with polymerising media.
- 45 | **Threaded holder** for small assembly groups.

## + Signalling Devices

- 43 | **SK** with signalling cable for connection to a closed circuit.
- 43 | **SKK, SGK** as integrated signalling device for connection to a closed circuit.
- 43 | **SNR** with proximity sensor, for bi-directional rupture discs.
- 43 | **BIRD** contains a ceramic bar with integrated electrical conductors, also for high temperatures.
- 43 | **SLL** Signalling via an optical fibre.
- 43 | **SB, SB-S, SBK-S** as retrofittable signalling (available with or without vent hole).
- 43 | **FOS** with fiber optic rupture membrane.
- 44 | **NIMU** as non-invasive signalling (suitable for highest tightness requirements).

## + Breather Valve

- 45 | **ELEVENT®** optimally protects vessels and tanks with low design pressures against overpressure + vacuum.

## + TEP

- 46 | Effective protection against weather and environmental influences

## + Safetyneering

- 47 | 5 Elements for maximum safety.
- 48 | **Individually manufactured with passion + team spirit.**
- 50 | **Operational safety.**
- 52 | **Complete solutions with real added value: REMBE® CAE.**
- 54 | **Sustainability.**
- 55 | **The REMBE® locations.**

# Process Safety Basics.

REMBE® rupture discs are technically highly developed, precise equipment parts with a safety function, for the protection of pressure equipment. They are individually manufactured and tested for each application. They open at a precisely predefined pressure and release it from the system.

## Advantages

- ✓ Instant response.
- ✓ Full bore opening available for pressure relief
- ✓ Leak-tight.
- ✓ Fast replacement with the REMBE® RushOrder Service.

They protect plants, people, the environment and machinery against the dangers resulting from excessive overpressure or vacuum within a process. Rupture discs were originally a very simple solution. However, over recent years, designs have advanced significantly to accommodate changing system requirements, such as pressure cycling, higher process

temperatures and the increasing role played by technology in many industrial processes. The greatest advantage of rupture discs over electronic and pneumatically operated safety systems is their reliability – this makes them one of the most important fail-safe safety devices in industrial operations.

Our rupture discs can be used as either a primary or secondary relief devices. They can also be used in combination with safety valves. The advantage here is that the valve is protected against contamination by the product or corrosion damage. This is often an attractive and cost-effective option.

All REMBE® rupture discs are made in Germany and certified in accordance with the Pressure Equipment Directive (2014/68/EU) as well as all widely recognised and sector-specific international regulations and standards. Among others, these include ASME Sec. VIII, Div. 1, KOSHA (South Korea).



Reliable. German.  
Safety. ●●●●

## The dangers of excessive pressure

Overpressure and vacuum a feature of virtually every production process. If the pressure rises above or falls below the specified limits, major damage to plant components may result. The consequences are production standstills and serious commercial losses. A reliable and fast reacting pressure relief system is therefore essential to protect the plant in case the pressure rises above or falls below these limits.

## Key technical figures of rupture discs

### Dimensions

The diameter of the rupture discs is specified matching the diameter of pipes or flanges as the nominal pipe size DN (Diamètre nominal) in the European context, or as NPS (Nominal Pipe Size) in other regions.

### Burst pressure (also referred to as set pressure)

This is the pressure at which the rupture disc opens. It is selected in such a manner, that the rupture disc opens before there is any system damage. The burst pressure is above the prevailing pressure during normal operation (also referred to as working pressure or process pressure) and below the pressure resistance (MAWP) of the respective system. Example: At an operating pressure (working pressure) of 1 bar and a 2 bar pressure resistance (MAWP) of the system, the burst pressure is at max. 2 bar or lower, depending on the type of rupture disc.

### Burst tolerance

Defines the tolerance around the defined burst pressure at which the rupture disc opens. If a rupture disc type has a burst tolerance of +/- 10% and the defined burst pressure is 1 barg, the rupture disc opens between 900 mbarg and 1.1 barg at the corresponding specified burst temperature.

The burst tolerances are designed in accordance with regulatory (e.g. PED or ASME) or customer-specific requirements.

### Burst temperature

Rupture disc temperature associated with a burst pressure, corresponding to the expected temperature of the rupture disc at the time of response.

### Discharge cross-section (also relief area)

Released cross-sectional area specified by the manufacturer after the rupture disc has responded for the discharge of the gas or fluid.

### Operating ratio (also working pressure ratio)

Ratio between the working pressure and the lower limit value of the burst pressure (also minimum burst pressure).

## What should I be aware of when selecting a rupture disc?

Reliable and cost-effective REMBE® rupture discs are not standardised products. Our specialists always adapt them individually to the specific operating conditions of your processes. We consider a wide range of parameters to ensure that every rupture disc functions perfectly.

These parameters include:

- ✓ System to be protected and process specifics
- ✓ Burst pressure
- ✓ Burst temperature
- ✓ Permissible overpressure or vacuum
- ✓ Process medium
- ✓ Operating pressure (process pressure)
- ✓ Vacuum resistance
- ✓ Pulsation
- ✓ Nominal diameter
- ✓ Necessary vent area or mass flow to be discharged

## Typification of domed rupture discs

### Reverse acting rupture discs (convex domed rupture disc)

This rupture disc with dome directed against the process media permits very high operating pressures (see also: technical key figures of rupture discs) and a high operating ratio.

### Forward acting rupture discs (concave domed rupture disc)

The dome of the rupture disc faces away from the process.

### Compact rupture discs

Mostly very small nominal diameters of reverse or forward acting rupture discs, which are often welded or soldered to the housing/holder.







RushOrder

# REMBE® RushOrder: The fastest way to get your customised rupture disc.

On workdays, weekends or even public holidays: we are at your service around-the-clock. With the REMBE® RushOrder Service we guarantee immediate production and delivery of your rupture discs. Available for both new and repeat orders.

Take advantage of this unique service

- ✓ reduce your warehousing costs
- ✓ prevent downtime in your plant
- ✓ Increase the productivity of your plant with sophisticated REMBE® rupture disc solutions

You can contact us any time – day or night –  
at T +49 2961 7405-0





# Reverse Acting Rupture Discs: Maximum reliability at high standard operating ratios\*.

Reverse acting rupture discs are installed with the domed side of the rupture disc facing the process. In this configuration, the rupture disc offers a higher standard operating ratio and better vacuum resistance. It is more resistant, more rugged and gives a longer service life.

A higher standard operating ratio allows you to operate your system under a higher load without the risk of fatigue or premature opening of the rupture disc.

Since REMBE® rupture discs have an exceptionally long service life, they minimise the risk of commercial losses caused by production downtime.

A specially developed production process using lasers guarantees that REMBE® rupture discs offer maximum reliability, precision and manufacturing repeatability.

\* The working pressure/operating ratio describes the quotient of minimum burst pressure and working operating pressure.

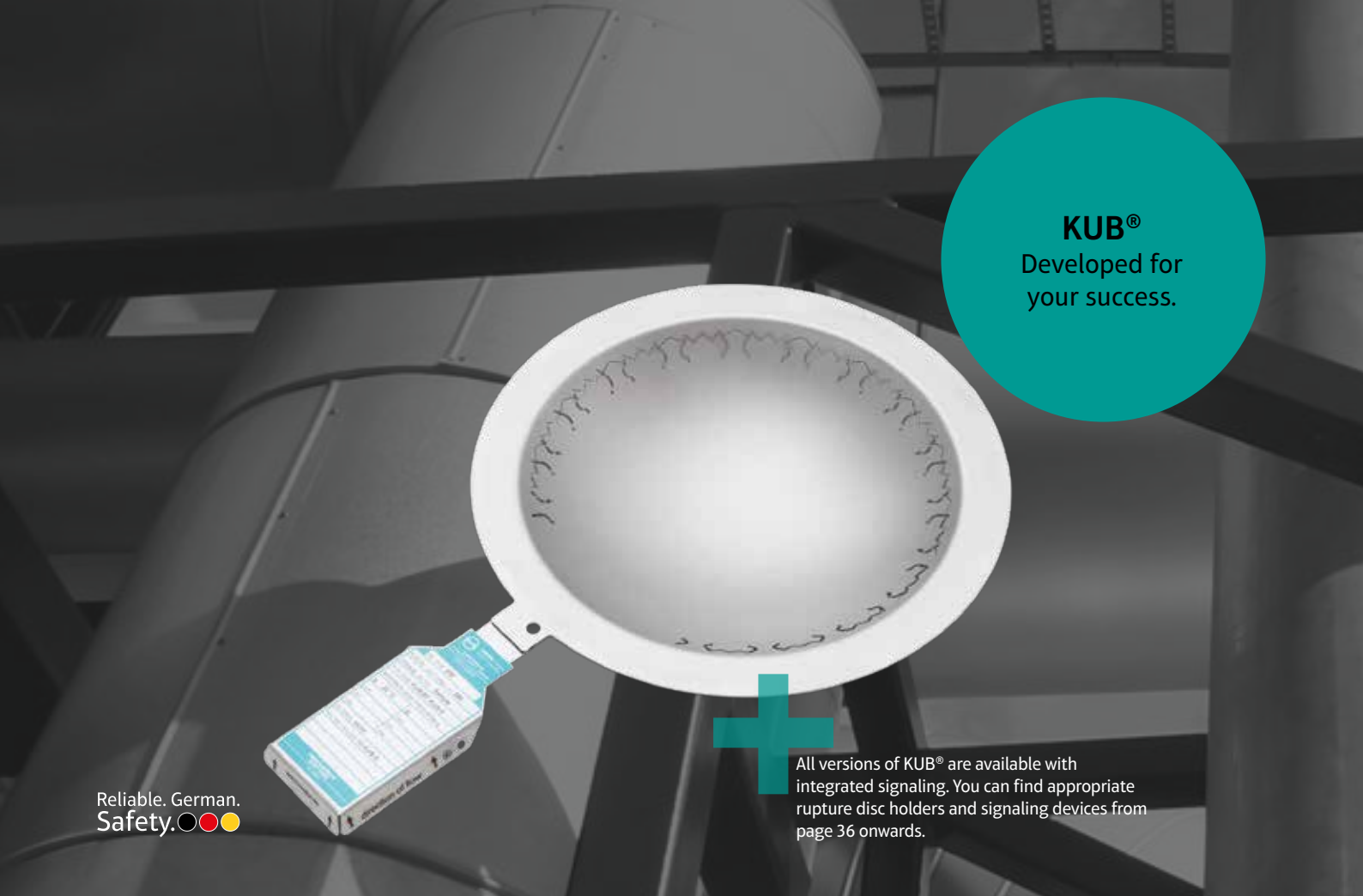

**KUB®**  
Developed for  
your success.

Reliable. German.  
Safety. ●●●



All versions of KUB® are available with integrated signaling. You can find appropriate rupture disc holders and signaling devices from page 36 onwards.

The KUB® is the only rupture disc in the world in which the burst pressure is determined based on Euler's critical load formula to give you **the most robust, efficient and durable high performance rupture disc on the market**. Unlike other rupture disc solutions where a weak point is created in the metal, the KUB® is a unique, highly engineered solution, benefiting from a series of buckling pins which accurately collapse for reliable, full bore, opening. As there is no specific weak point on the rupture disc, the KUB® is an **extremely robust solution, almost immune to damage** by incorrect handling, improper installation or even being dropped (from waist level).

This maximises the lifespan of the disc and minimises long-term investment by lowering ongoing replacement costs. The KUB® features a two-layer design, with the smooth, unblemished surface of the sealing membrane facing the process **minimising the possibility of damage due to corrosion**.

Boasting a 98% operating ratio, the KUB® is not subject to fatigue even at higher operating pressures\* and in the most demanding of process conditions in vapour, gas, liquid or two-phase applications. Unlike many other reverse acting discs, the unique construction of the KUB® makes it fully compatible with liquid-only applications, maximising installation points which can benefit from this rupture disc, simplifying customers' installation, maintenance and purchasing routines.

\* Depending on the respective application.

Suitable for full vacuum and back pressure resistant, the KUB® with its non-fragmenting design can be installed upstream of a safety valve to isolate the valve from the process. When used in combination, the KUB® will ensure the best possible condition of the safety valve, significantly extending service intervals and overall life of the valve while maximising return on investment. The leak-tight design prevents emissions and the associated costs whilst protecting the safety valve from corrosive, aggressive or adhesive media.

### Applications

Isolation of safety valves, refineries, chemical plants, petrochemical plants, power plants, chemical reactors, process vessels, distillation towers, heat exchangers, separators, condensers, cryogenic applications, geothermal energy, reverse osmosis systems, desalination plants

### Industries

Breweries, petrochemical, food, oil and gas industry, aerospace, pharmaceutical industry, LNG

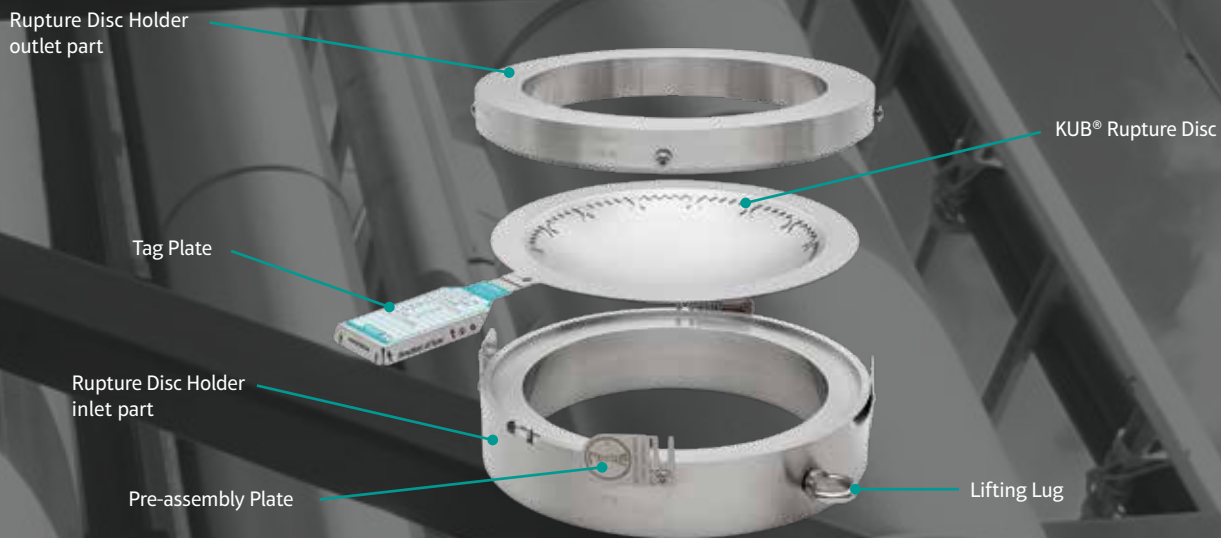

## Advantages

- ✓ **Unique buckling pin element** – creates the most robust rupture disc design available.
- ✓ **Reinstall and reuse with ease after inspection** – guarantees maximum lifespan of one rupture disc, reducing spares costs.
- ✓ **Torque independent burst pressure.**
- ✓ **Virtually immune to damage during installation, transport or storage** – maximises process uptime and unnecessary replacement costs.
- ✓ **Extend safety valve lifespan** – robust design protects valves from process media, reducing corrosion risk and minimizing overall investment.
- ✓ **Widest size and burst pressure range** in a single reverse acting disc – one-disc type suitable for a wide range of process conditions, improving purchasing, inspection and maintenance routines.
- ✓ **Compatible with liquid-only applications** – maximises installation points where the benefits of this technology can be achieved.

The KUB® rupture disc has a robust design and can be removed, inspected, cleaned and reinstalled. Any damage is easy to detect with the naked eye.

Process medium	Suitability
Gas   Steam	✓✓
Liquid with gas cushion	✓✓
Liquids	✓
Two phase flow	✓
Hygienic applications	✓✓
✓✓ recommended	
✓ suitable	

## Certifications



Works Certificate



PED



ASME



KOSHA (South Korea)



CML (China)



TR ZU (EAWU)

# Rupture Disc for hygienically demanding Processes.

KUB® clean  
for aseptic  
operating  
conditions.

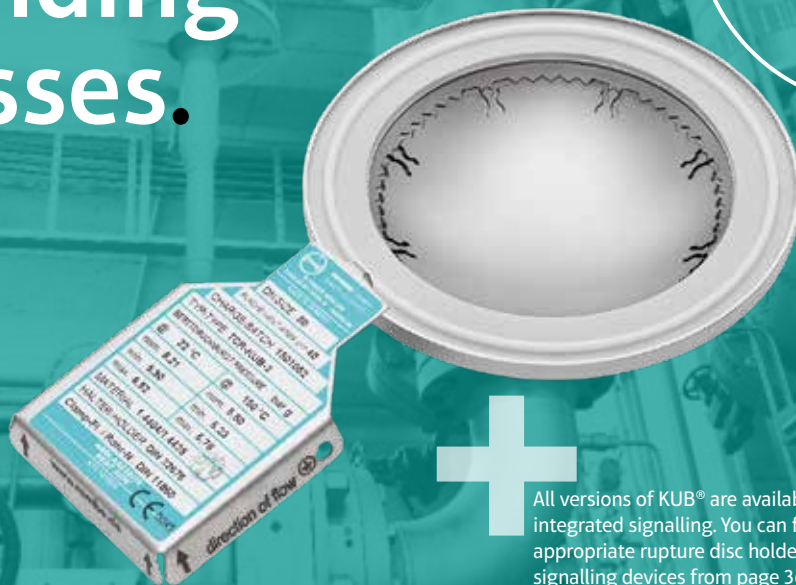

All versions of KUB® are available with integrated signalling. You can find appropriate rupture disc holders and signalling devices from page 36 onwards.

Reliable. German.  
Safety. ●●●

KUB® clean raises the bar in the field of sanitary rupture discs: **KUB® has a completely leak-tight and smooth design that guarantees perfect hygiene standards in sanitary applications.**

KUB® clean is simple to install in existing tri-clamp flange systems. It complies with all hygienic design requirements and is suitable for CIP and SIP applications. The unique construction of the KUB® with its totally smooth sealing membrane means that the rupture disc has no score lines, indentations or notches on the process side eliminating trapped product residues during production or cleaning cycles.

The design of the KUB® clean together with the integrated gasket and direct installation into tri-clamp connectors results in a simple and extremely hygienic solution.

## Applications

Autoclaves, Isolation of safety valves, food production, mixers, process vessels, reactors, spray dryers, sterile tanks, aseptic tanks

## Industries

Breweries, food, life science, pharmaceutical industry

## Advantages

- ✓ **Easy-to-replace, integrated clamp gasket** (compliant with FDA and USP Class VI).
- ✓ Extremely robust design ensures a **longer service life** for longer production runs without downtime.
- ✓ **Broad range of pressures** and nominal size possible.
- ✓ **Easy to install** directly in tri-clamp flanges.
- ✓ **Fulfils all the requirements of hygienic design.**

Process medium	Suitability
Gas   Steam	✓✓
Liquid with gas cushion	✓✓
Liquids	✓
Two phase flow	✓
Hygienic applications	✓✓
✓✓ recommended	
✓ suitable	

## KUB® V for isolating safety valves.



Reliable. German.  
Safety. ●●●●

More information on the protection of safety valves with rupture discs from page 32 onwards.

The KUB® V rupture disc protects safety valves against corrosive solids or adhesive media and is installed upstream of the safety valve inlet. It is certified to resist a back pressure of 135%<sup>1</sup> or more of the defined burst pressure and thus enables you to test safety valves in-situ without having to remove the valve for servicing.

<sup>1</sup> Depending on the specific application.

### Applications

Separators, Autoclaves, chemical reactors, distillation towers, flare stacks, FPSO applications, gas-tight pressure vessels, gas compressor modules, gas turbines for power generation, geothermal energy, isolation of safety valves, condensers, power plants, cryogenic applications, cryostats + transport containers, LDPE (thermoplastic), food production, mixers, oil and gas separation and treatment, petrochemical plants, process vessels, refineries, reactors, spray dryers, sterile tanks, aseptic tanks, reverse osmosis systems, heat exchangers

### Industries

Breweries, petrochemical, food, oil and gas industry, pharmaceutical industry, LNG

### Advantages

- ✓ **Longer service life and service intervals** for the safety valve due to isolation of the valve from the process.
- ✓ **Reduction in safety valve maintenance costs** and the amount of production downtime required by in-situ tests.
- ✓ **You can use safety valves manufactured from lower cost materials** because they are isolated from the process medium during normal operation.
- ✓ **Leak-tight design** prevents emissions.

Process medium	Suitability
Gas   Steam	✓✓
Liquid with gas cushion	✓✓
Liquids	✓
Two phase flow	✓
Hygienic applications	✓✓
✓✓ recommended	
✓ suitable	

**KUB® F**  
for installation  
directly between  
flanges.



All versions of KUB® are available with integrated signalling. You can find appropriate rupture disc holders and signalling devices from page 36 onwards.

Reliable. German.  
Safety. ●●●

For burst pressures of up to 1 barg, the KUB® F can be installed directly between flanges in a variety of applications. This makes it ideal for applications in which reliability and a precise design pressure in the low pressure range are essential.

### Applications

Separators, Autoclaves, chemical industry, chemical reactors, distillation towers, flare stacks, gas-tight pressure vessels, gas compressor modules, gas turbines for power generation, isolation of safety valves, intermodal containers for corrosive/aggressive media, condensers, power plants, cryogenic applications, food production, mixers, oil and gas separation and treatment, petrochemical plants, process vessels, refineries, reactors, spray dryers, sterile tanks, aseptic tanks, reverse osmosis systems, heat exchangers, silos

### Industries

Breweries, petrochemical, food, oil and gas industry, Aerospace, pharmaceutical industry

### Advantages

- ✓ High working pressure conditions operating ratios.
- ✓ Direct installation between flanges.
- ✓ Suitable for aseptic requirements due to extremely smooth surface of the sealing membrane.

Process medium	Suitability
Gas   Steam	✓ ✓
Liquid with gas cushion	✓ ✓
Liquids	✓
Two phase flow	✓
Hygienic applications	✓ ✓
✓ ✓ recommended	
✓ suitable	



**IKB®**  
the rupture disc  
with the patented  
manufacturing  
process.

Reliable. German.  
Safety. ●●●●

You can find appropriate rupture disc holders and signalling devices from page 36 onwards.

The IKB® rupture disc was developed to provide reliable protection against excessive overpressure and vacuum in equipment such as pressure vessels, pipe systems, gas cylinders and reactors. It is suitable for applications with gas, steam and liquids<sup>1</sup> as well as for isolating safety valves. IKB® permits a standard operating ratio of up to 95%<sup>2</sup>. The patented manufacturing process produces an instant, full and fragmentation-free opening across the full width of the vent. A high quality rupture disc produced without the need for mechanical scoring or knife constructions. This ensures exceptionally high resistance even under cyclic loads. The extremely simple installation of a suitable rupture disc holder is torque-independent and requires no special tools.

<sup>1</sup> If there is a gas cushion upstream of the rupture disc.

<sup>2</sup> Depending on the specific application.

## Applications

Separators, Autoclaves, chemical reactors, distillation towers, desalination plants, flare stacks, FPSOs, gas-tight pressure vessels, gas compressor modules, gas turbines for power generation, hazardous goods containers, geothermal energy, intermodal containers for corrosive/aggressive media, isolation of safety valves, condensers, power plants, cryogenic applications, cryostats + transport containers, LDPE (thermoplastic), food production, mixers, oil and gas separation and treatment, petrochemical plants, process vessels,

refineries, reactors, spray dryers, sterile tanks, aseptic tanks, reverse osmosis systems, heat exchangers

## Industries

Breweries, petrochemical, food, oil and gas industry, aerospace, pharmaceutical industry, LNG

## Advantages

- ✓ **Maximum safety even at high pressures.**
- ✓ **You can use safety valves manufactured from lower cost materials** because they do not come into contact with the medium during normal operation.
- ✓ **In-situ tests reduce safety valve maintenance costs.**

Process medium	Suitability
Gas   Steam	✓ ✓
Liquid with gas cushion	✓ ✓
Two phase flow	✓
Hygienic applications	✓ ✓
✓ ✓ recommended	
✓ suitable	





# Forward Acting Rupture Discs: State-of-the-art laser production techniques.

In forward acting rupture discs, the dome of the disc faces away from the process. At REMBE® we also use state-of-the-art laser production techniques when manufacturing forward acting rupture discs.

With a wide choice of materials and designs, we can supply the perfect rupture disc for every application – customised for your process.

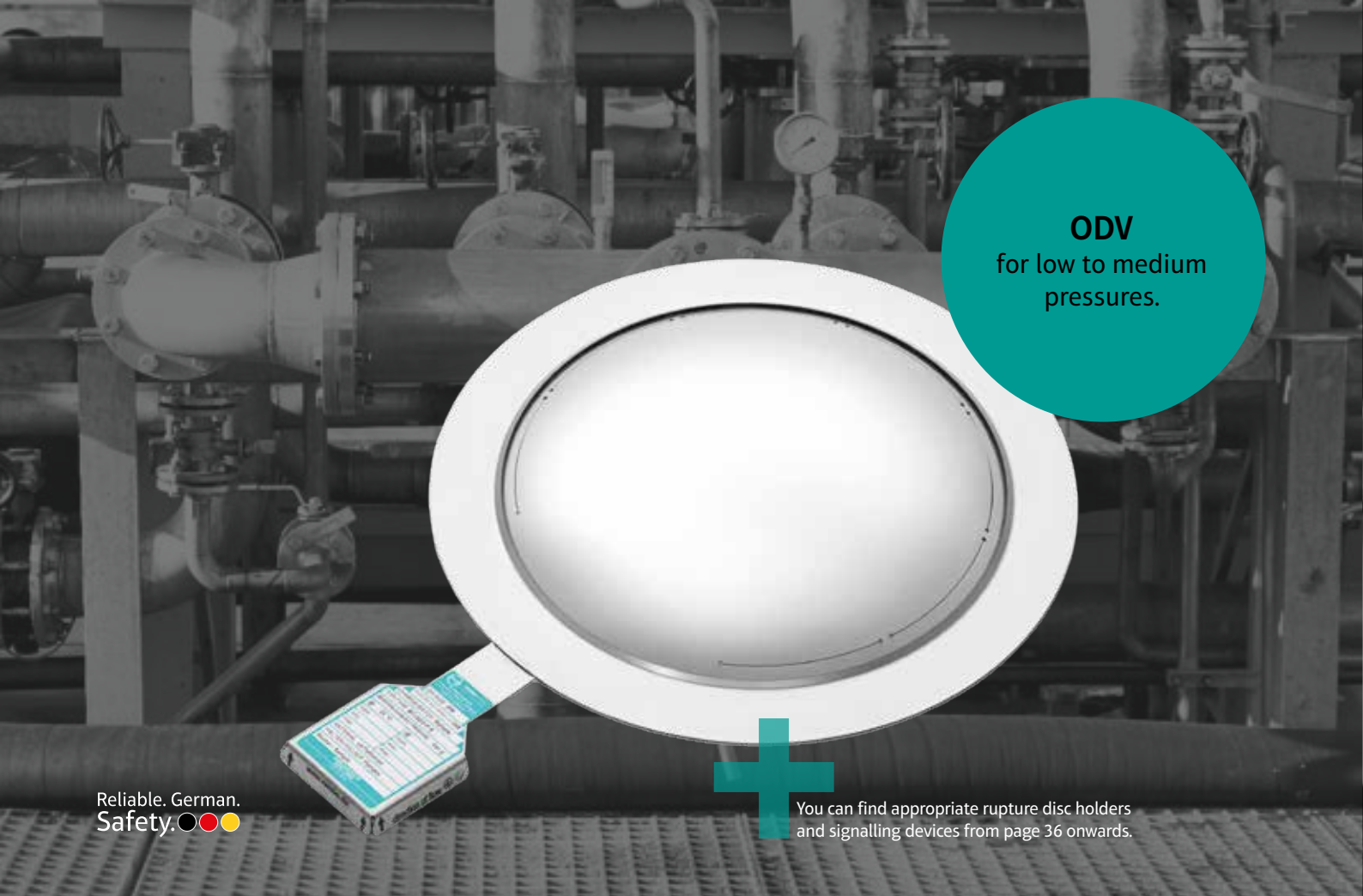

Reliable. German.  
Safety. ●●●●

You can find appropriate rupture disc holders and signalling devices from page 36 onwards.

ODV is primarily used for applications with low to medium pressures, e.g. for gases, liquids and applications with two-phase flows. The disc has a standard operating ratio of max. 80 %\*. For burst pressures of less than 1 barg, ODV can be installed directly between flanges or angular rings.

The burst element is located on the side facing away from the process to protect it against corrosive media. The breaking points are cut into the burst element using lasers and define the burst pressure by length, number quantity and geometry. The sealing element prevents gases from escaping in normal operation. The vacuum support, as the name suggests, enables ODV to be used in processes with a vacuum.

\* Depending on the specific application.

### Applications

Autoclaves, chemical reactors, distillation towers, desalination plants, flare stacks, FPSOs, gas compressor modules, geothermal energy, condensers, power plants, food production, mixers, oil and gas separation and treatment, petrochemical plants, process vessels, refineries, spray dryers, sterile tanks, aseptic tanks, reverse osmosis systems, heat exchangers, water injection pumps

### Industries

Breweries, petrochemical, food, oil and gas industry, silo, pharmaceutical industry, LNG

### Advantages

- ✓ Suitable for use even with full vacuum due to integrated vacuum support.
- ✓ Minimum fragmentation during opening.
- ✓ Accurate performance and opening.
- ✓ Coverage of a wide pressure range – maximises the possible installation points, reduces the number of variants in your system and simplifies purchasing, inspection and maintenance processes.
- ✓ Versatile, corrosion resistant solution – triple-section construction ensures **maximum corrosion resistance** for long-term, reliable performance.
- ✓ Compatible with a wide range of process conditions – **versatile cost-effective** solution suitable for numerous applications.

Process medium	Suitability
Gas   Steam	✓✓
Liquid with gas cushion	✓✓
Liquids	✓✓
Two phase flow	✓✓
✓✓ recommended	
✓ suitable	

**STAR**  
for low to high  
pressures.

Reliable. German.  
Safety. 

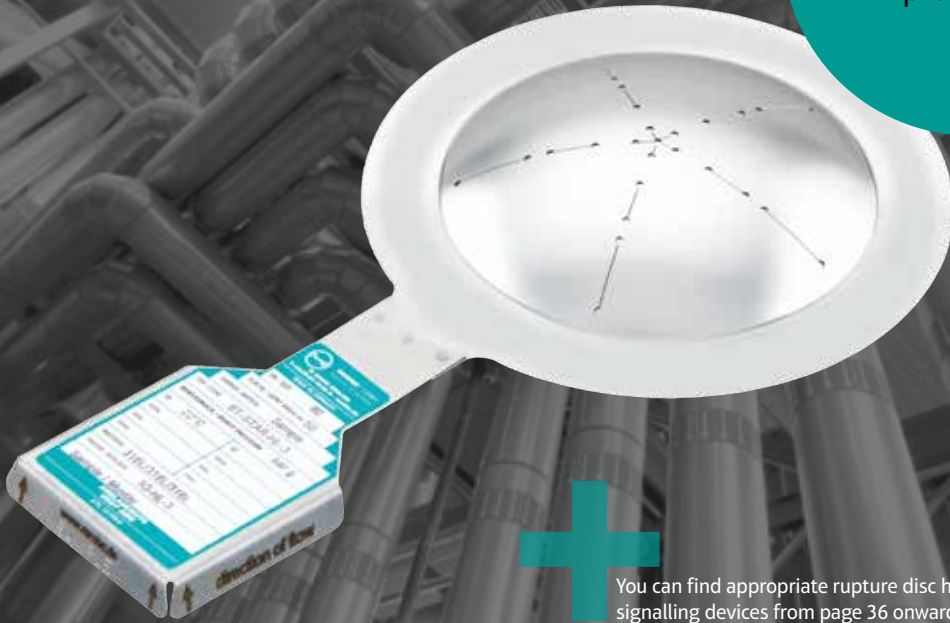

You can find appropriate rupture disc holders and signalling devices from page 36 onwards.

STAR is a triple-section solution primarily used in applications with low to high response pressures, especially in the oil and gas industry, petrochemicals and chemicals, applications with liquified gases and processes that involve pressure cycling. The standard operating ratio is up to 80%\* of the minimum response pressure. Extremely tight tolerances of +/- 5% are possible. For applications with a burst pressure of less than 1 barg, STAR can be installed directly between flanges. The advanced manufacturing process guarantees minimum fragmentation when opening even at the highest pressures. Its star-shaped opening pattern is flatter than that of other rupture discs so it requires less installation height. The integrated vacuum support guarantees high vacuum resistance.

<sup>1</sup> Depending on the respective application.

## Applications

Separators, autoclaves, chemical reactors, distillation towers, desalination plants, flare stacks, FPSOs, gas-tight pressure vessels, gas compressor modules, gas turbines for power generation, geothermal energy, high pressure applications, isolation of safety valves, condensers, power plants, LDPE (thermoplastic), food production, mixers, oil and gas separation and treatment, petrochemical plants, process vessels, refineries, reactors, spray dryers, reverse osmosis systems, heat exchangers, water injection pumps, silos

## Industries

Breweries, petrochemical, food, oil and gas industry, LNG

## Advantages

- ✓ **Minimal space required** due to star-shaped opening pattern.
- ✓ **Cost-effective** as different materials can be used for the individual elements of the rupture disc.
- ✓ **Minimum risk of fragmentation** even at high pressures.
- ✓ **Also suitable for isolating safety valves.**
- ✓ Durable, low-profile solution – **ensures superior performance and long life-cycle even where pressure cycling or vacuum conditions are present.**
- ✓ **Corrosion resistant and cost-effective.**
- ✓ **Unique star-shaped construction** – low profile enables simpler installation and reduced holder costs.

Process medium	Suitability
Gas   Steam	✓✓
Liquid with gas cushion	✓✓
Liquids	✓✓
Two phase flow	✓✓
✓✓ recommended	
✓ suitable	

**SFD**  
for low to high  
pressures.

Reliable. German.  
Safety. 

You can find appropriate rupture disc holders and signalling devices from page 36 onwards.

SFD is a laser sublimated rupture disc available in sizes up to 24". Due to its vacuum resistance and the wide range of response pressures from 2 to 431 barg, SFD is ideal for a variety of gas or liquid applications, in the oil and gas industry, petrochemicals and chemicals as well as many others.

The standard operating ratio is up to 80 %\* of the minimum response pressure.

The advanced laser manufacturing process guarantees fragmentation free opening even at the highest pressures. Sublimated on the vent side, the SFD offers a smooth process face which reduces the risk of corrosion.

\*Depending on the specific application.

## Applications

Separators, autoclaves, chemical reactors, desalination plants, flare stacks, FPSOs, gas-tight pressure vessels, gas compressor modules, gas turbines for power generation, hazardous goods containers, geothermal energy, high pressure applications, intermodal containers for corrosive/aggressive media, isolation of safety valves, condensers, power plants, cryogenic applications, cryostats + transport containers, LDPE (thermoplastic), food production, mixers, oil and gas separation and treatment, petrochemical plants, process vessels, refineries, reactors, spray dryers, reverse osmosis systems, heat exchangers, water injection pumps, silos

## Industries

Breweries, petrochemical, food, oil and gas industry, aerospace, pharmaceutical industry, LNG

## Advantages

- ✓ Space saving due to the low profile opening pattern.
- ✓ Non-fragmenting design
- ✓ Suitable for the isolation of safety valves.
- ✓ Smooth process face.
- ✓ Manufactured with REMBE® CPX™ Technology: Reduces downtime caused by premature failure, corrosion or pin-holing.
- ✓ Compatible with a wide range of process conditions.

Process medium	Suitability
Gas   Steam	✓✓
Liquid with gas cushion	✓✓
Liquids	✓✓
Two phase flow	✓✓
✓✓ recommended	
✓ suitable	

# Single Layer Rupture Disc

**BT**  
for simple applications with medium to high pressures.



Reliable. German. Safety. ●●●

You can find appropriate rupture disc holders and signalling devices from page 36 onwards.

The rupture disc that started it all many decades ago. Even now, this forward acting rupture disc is still a good choice for simple applications with medium to high pressures, such as in pumps, in the petrochemical and chemical industries or in hydraulics. The standard operating ratio is up to 70%\* of the minimum response pressure.

The burst pressure is determined by the tensile strength and thickness of the material. Also available with integrated vacuum support for total vacuum resistance.

\* Depending on the specific application.

## Applications

Autoclaves, distillation towers, gas-tight pressure vessels, condensers, power plants, food production, petrochemical plants, process vessels, refineries, reactors, water injection pumps

## Industries

Breweries, petrochemical, food, oil and gas industry, pharmaceutical industry

## Advantages

- ✓ Easy to use.
- ✓ Wide range of materials available.

Process medium	Suitability
Gas   Steam	✓✓
Liquid with gas cushion	✓✓
Liquids	✓
Two phase flow	✓
Hygienic applications	✓✓

✓✓ recommended  
 ✓ suitable

## Certifications



Works Certificate



PED



KOSHA (South Korea)



CML (China)



TR ZU (EAWU)

Reliable. German.  
Safety. ●●●●



**ZW**  
opens in vacuum or  
in the overpressure  
direction.

The bi-directional rupture disc opens in one direction for a defined overpressure and in the other direction for vacuum. It is primarily used in storage tanks and processes involving gases or liquids. The rupture disc permits a standard operating ratio of 80%\* in the overpressure direction and 70%\* in the vacuum direction. The bi-directional rupture disc can be supplied with an integrated SNR signalling unit (see page 41). When the disc ruptures in either the overpressure or vacuum direction, the SNR gives an open circuit signal to advise of an activation.

By combining the principles of the KUB® reverse acting rupture disc with the buckling pin and the triple-section design of the ODV forward acting rupture disc, we can offer you a rupture disc that responds at two different but precisely defined burst pressures.

\* Depending on the specific application.

## Applications

Chemical reactors, power plants, oil and gas separation and treatment, petrochemical plants, process vessels, refineries, silos

## Industries

Breweries, petrochemical, food, oil and gas industry, pharmaceutical industry

## Advantages

- ✓ Performs the work of two rupture discs at one installation point.
- ✓ **No additional holder required:** mounted directly between flanges or angular rings.
- ✓ Suitable for a **wide range of applications.**

Process medium	Suitability
Gas   Steam	✓✓
Liquid with gas cushion	✓✓
Liquids	✓
Two phase flow	✓
Hygienic applications	✓
✓✓ recommended	
✓ suitable	





For  
installation  
directly  
between  
flanges.

Also available in a vacuum resistant version.

# Flat Rupture Discs: Full-bore opening with minimum fragmentation.

They can be produced in virtually any size, for extremely low pressures from 15 mbar and with very low burst tolerances. For protection against overpressure and vacuum, e.g. in storage vessels and low pressure systems. Also suitable as a secondary safety device alongside breather valves. This rupture disc is designed to work at standard operating ratios of up to 50 %\* of the min. response pressure. It is installed directly between flanges and due to its half holes is suitable for all flange systems. A wide range of materials can be used as seals.

\* Depending on the respective application.

## Applications

Power plants , Oil and gas separation and treatment, petrochemical plants, process vessels, refineries

## Industries

Breweries, petrochemical, food, oil and gas industry, aerospace, pharmaceutical industry

## Advantages

- ✓ Requires less space than a safety valve due to the lower installation height.
- ✓ Available for all flanges and in any nominal width.
- ✓ No holder required for installation.
- ✓ Also available in a vacuum resistant version.

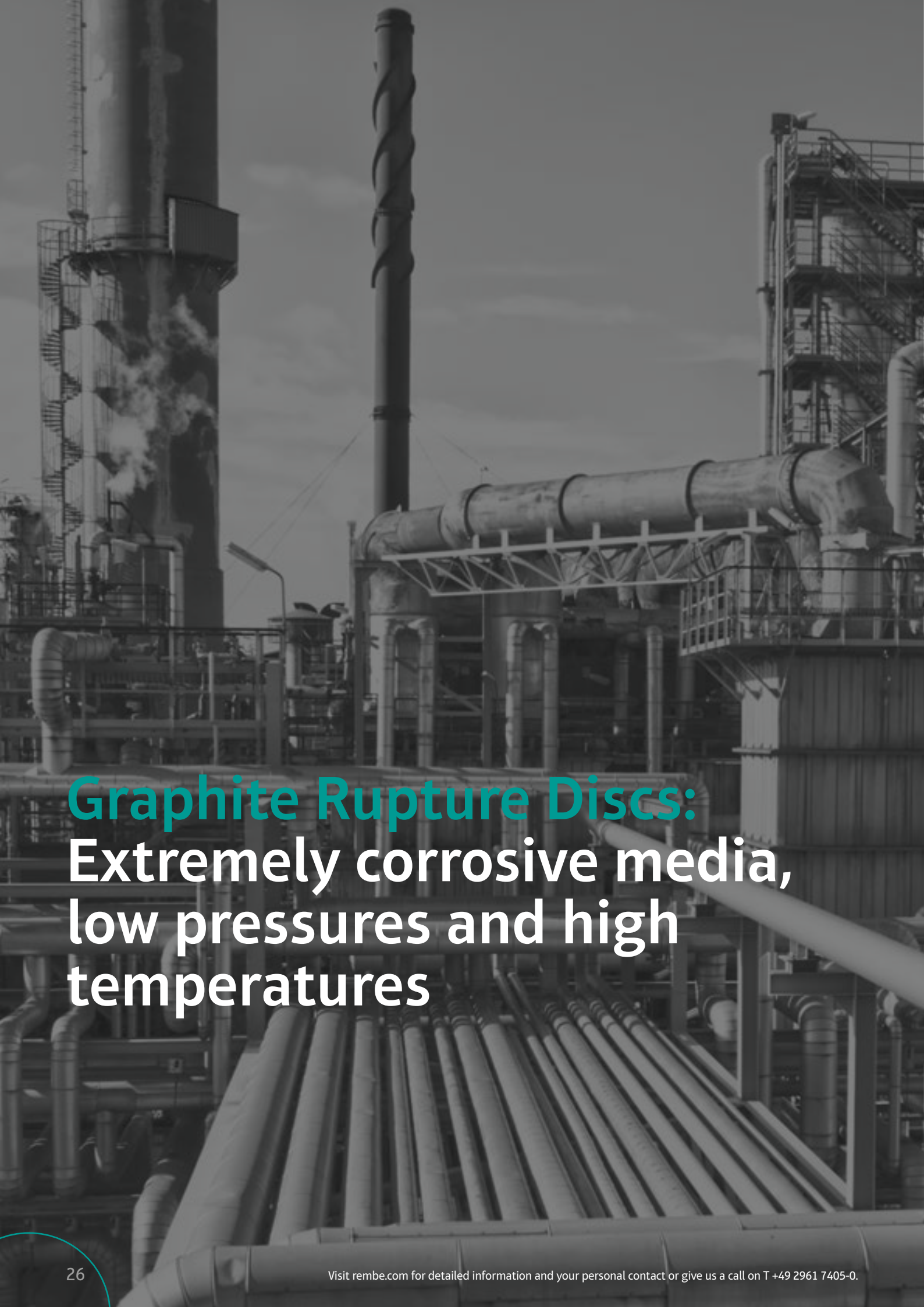
A grayscale photograph of an industrial facility, likely a refinery or chemical plant. The image shows a complex network of pipes, metal structures, and tall towers. In the foreground, several large pipes run parallel to each other. In the background, there are tall distillation columns and a network of walkways and ladders. The sky is overcast. The overall tone is industrial and technical.

# Graphite Rupture Discs: Extremely corrosive media, low pressures and high temperatures



**GRX®**  
for extremely  
corrosive media in  
connection with low  
pressures + high  
temperatures.

Reliable. German.  
Safety. ●●●●

REMBE® graphite rupture discs offer you the familiar REMBE® quality and reliability – even with extremely corrosive media, low pressures and high temperatures. Like all REMBE® rupture discs, the graphite rupture discs are also manufactured in Germany. The maximum working pressure is 80 %\* of the minimum burst pressure.

REMBE® graphite rupture discs are applicable for highest temperatures by using a unique chemical vapour deposition method (PyC coating). The rupture discs are applicable from -180 °C up to +500 °C under oxidizing and reducing atmosphere, +1,500 °C under inert conditions. Versions with vacuum and back pressure support are also suitable for the above mentioned operating conditions.

Depending on the application and nominal pipe size, the rupture discs are installed directly between flanges. If required, you will also receive a suitable signalling device which, in conjunction with your process control system, will inform you about the rupture disc's response. Nominal pipe size available from DN 15 (0.5") to DN 600 (24") with burst pressures from 20 mbarg (~0.3 psig) to 63 barg (~900 psig).

## Applications

Separators, autoclaves, chemical industry, chemical reactors, gas compressor modules, gas turbines for power generation, intermodal containers for corrosive/aggressive media, condensers, power plants, cryostats + transport containers, oil and gas separation and treatment, petrochemical plants, process vessels, refineries, reactors, silos, water injection pumps

## Industries

Breweries, petrochemical, food, oil and gas industry, pharmaceutical industry, hydrogen

## Advantages

- ✓ **Product purity** (carbon content  $\geq 99,9$  % for PyC coating).
- ✓ **Highest temperature resistance** (+1,500 °C under inert conditions) and leak-tightness due to an innovative coating.
- ✓ FDA-conformity.\*\*
- ✓ **Highest corrosion resistance.**
- ✓ Extra long service life.
- ✓ Temperature-independent material properties and burst pressures.
- ✓ Reusable vacuum support.
- ✓ Manufacturing without polymer sealant.
- ✓ Simple installation.

\* Depending on the respective application.

\*\* Excluding processes with infant food and breast milk.

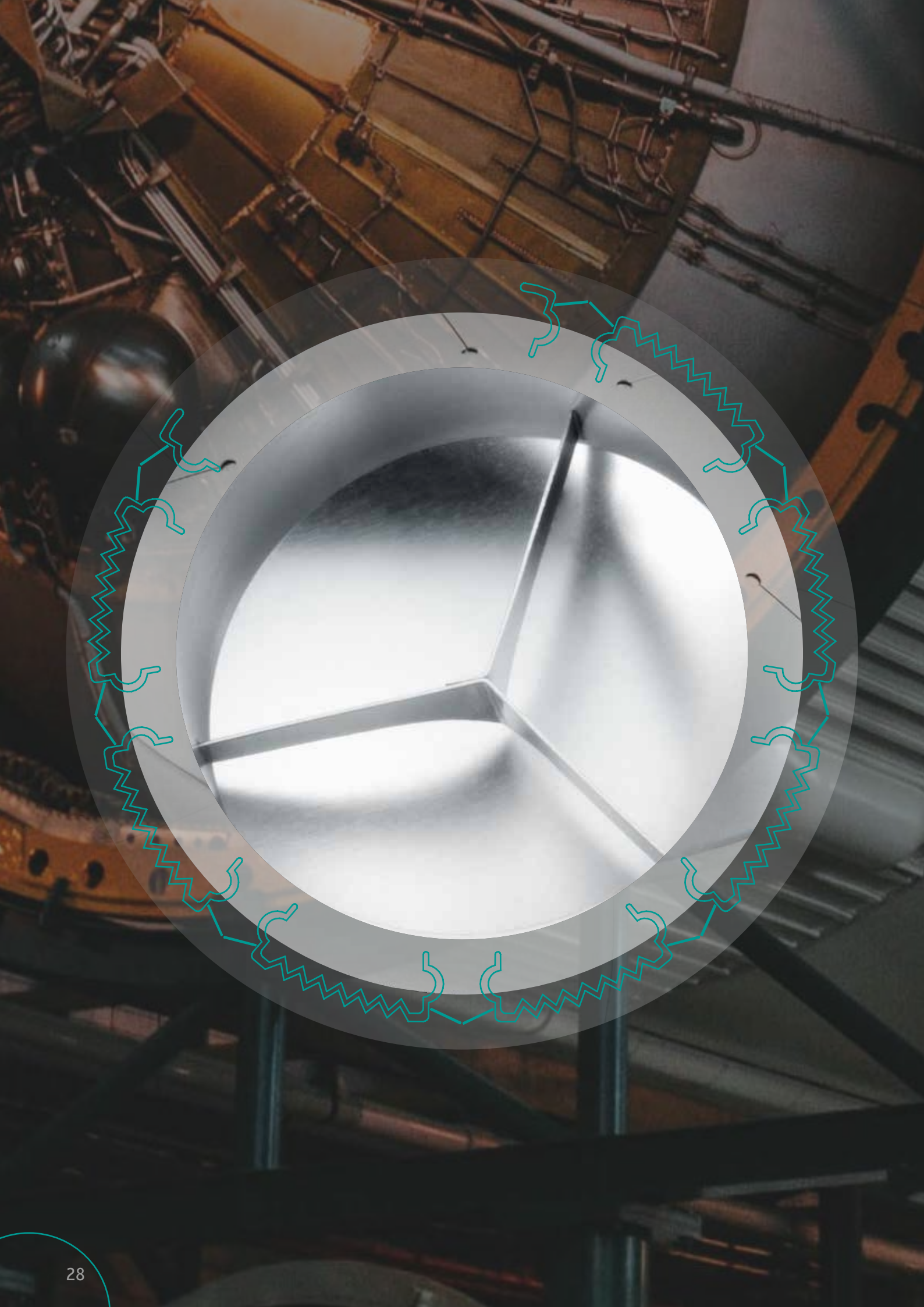

# Customised Compact Rupture Discs: Specially manufactured for your challenges.

Very high or low pressures, high vacuums, temperatures of several hundred degrees Celsius, highly volatile media or difficult installation situations – if your processes have exceptionally high pressure relief requirements, you will find the optimum solution in the following section. We have even successfully protected space satellites against overpressure.

All the rupture disc models presented here can be customised to meet any requirements in terms of connections, nominal widths, housing geometries, pressures or temperature resistance. They are all developed, manufactured and tested in accordance with your specifications. We give you access to more than 40 years of experience in the development and production of special rupture discs – and one of the world's largest warehouse of raw materials in the sector. With more than 1,000 different starting materials, we offer you fast and reliable pressure protection solutions.

A selection of the materials stored in our warehouse: Highest grade stainless steels, such as 316L, Nickel, Monel, Inconel, Hastelloy, Tantalum, Titanium or Zirconium. In addition, we stock a variety of precious metals and high performance plastics.

## Advantages

- ✓ The potential for use in applications **over an extremely wide range of temperatures and pressures.**
- ✓ **Maximum leak-tightness.**
- ✓ **Customised design** of the housing and connections as well as **the smallest nominal widths.**
- ✓ Corrosion resistance.

A selection of the available connections: CF/KF flange, ISO-K / ISO-F flange, VCR fitting, Weld neck flange (also with tongue and groove), Compression fitting, Threaded fitting

# Rupture Discs in distant worlds.

**UKB LS**  
maximum leak-  
tightness, also  
suitable for use in  
high vacuum.



Reliable. German.  
Safety.

You can find appropriate signalling devices  
from page 36 onwards.

The UKB LS comprises a customisable housing, a reverse acting rupture disc and a three-section knife. When the defined burst pressure is reached, the rupture disc is pressed against the knife and opens. This design provides the lowest possible burst pressures while at the same time offering good vacuum resistance even up to high vacuum conditions. The rupture disc and housing are micro-welded and all elements are made of metal. This ensures maximum leak-tightness. Leakage rates of up to  $10^{-10}$  mbar xl/s are possible. With a wide array of available connections, we supply the ideal pressure relief unit for every application – even for ultra-clean processes. Despite its individuality, a number of “standard” sizes have become established for UKB LS over the last few decades. These are for installation between industry standard flanges.

## Applications

Autoclaves, chemical reactors, gas-tight pressure vessels, gas compressor modules, hazardous goods containers, intermodal containers for corrosive/aggressive media, cryogenic applications, cryostats + transport containers, food production, mixers, process vessels, refineries, reactors, spray dryers, sterile tanks, aseptic tanks, reverse osmosis systems

## Industries

Breweries, petrochemical, food, oil and gas industry, aerospace, pharmaceutical industry, LNG

## Advantages

- ✓ Maximum leak-tightness.
- ✓ Also suitable for **high vacuum** applications.
- ✓ Out of this world: these rupture discs **even protect space satellites** – so you can be confident they will function reliably.

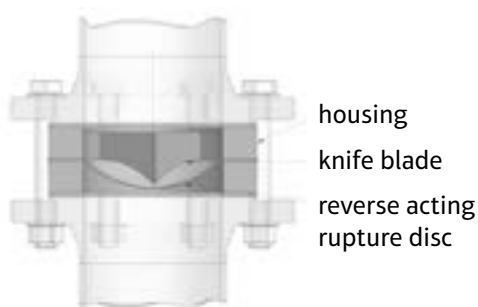

housing  
knife blade  
reverse acting  
rupture disc

Process medium	Suitability
Gas   Steam	✓ ✓
Liquid with gas cushion	✓ ✓
Two phase flow	✓
Hygienic applications	✓ ✓
✓ ✓ recommended	
✓ suitable	

**Plug Type**  
the individual  
alternative.

Reliable. German.  
Safety. ●●●●

Like UKB LS, plug type rupture discs consist of more than just the rupture disc itself – the housing is also part of the product and can be adapted to an extremely wide range of connections and geometries. Above all, plug type rupture discs are used to protect applications with high pressures and connections with small nominal widths.

In most cases, customers install single layer rupture discs. These are laser-welded for the tightest burst tolerances and absolute reliability. Depending on the model, the rupture disc can be welded without additional materials, fixed in position using special solder or clamped.

### Applications

Autoclaves, chemical reactors, gas-tight pressure vessels, gas compressor modules, high pressure applications, cryogenic applications, cryostats + transport containers, LDPE (thermoplastic), food production, mixers, petrochemical plants, process vessels, refineries, reactors, water injection pumps

### Industries

Petrochemical, food, oil and gas industry, aerospace

### Advantages

- ✓ The **smallest nominal widths** in combination with **very high burst pressures**.
- ✓ **Fully customisable** housing design.
- ✓ Easy to install.

Process medium	Suitability
Gas   Steam	✓✓
Liquid with gas cushion	✓✓
Liquids	✓
Two phase flow	✓
Hygienic applications	✓✓
✓✓ recommended	
✓ suitable	

**HPRD**  
for high pressures  
+ extreme  
temperatures.



Reliable. German.  
Safety. ●●●●

The geometry of our rupture discs offers you a valuable innovation: more stable and more durable rupture discs. By modifying the design of our existing rupture discs, we have made a crucial improvement: Unlike other high pressure rupture discs, the weld seam is not subjected to shear and bending forces – only to pressure. Anyone with a technical knowledge of this area understands that this makes a major difference. Geometrically separating the area under peak stress and the weld seam makes the rupture disc more durable and able to comply with the tightest burst tolerances – tolerances of +/- 3 % and better, depending on the specified burst pressure. The new HPRD rupture discs provide long-term protection for processes with temperatures up to 400 °C and pressures up to 5000 barg and beyond. They have already proved themselves under real process conditions and in a wide range of customer applications. These include reactors, autoclaves and compressors in a variety of high pressure processes, such as LDPE production.

### Applications

Autoclaves, chemical reactors, gas-tight pressure vessels, high pressure applications, LDPE (thermoplastic), petrochemical plants, reactors, water injection pumps

### Industries

Petrochemical, oil and gas industry

### Advantages

- ✓ **Extra long service life** even at the highest temperatures and pressures.
- ✓ Burst tolerance of +/- 3 % prevents premature rupture disc response and thus production standstills.
- ✓ **Design can be adapted in any way.**

Process medium	Suitability
Gas   Steam	✓✓
Liquid with gas cushion	✓✓
Liquids	✓
Two phase flow	✓
Hygienic applications	✓✓
✓✓ recommended	
✓ suitable	



**Extruder rupture discs**  
for plastics and food production.

You can find appropriate signalling devices from page 36 onwards.

Extruder rupture discs are a reliable solution for relieving excessive pressure in plastic and food extruders. Like all our customised rupture discs, the length, geometry, (threaded) connections, temperature resistance and response pressure can be tailored to your specific requirements. The rupture disc is welded or soldered into the housing.

The special gas-tight soldered or welded rupture disc membrane is installed directly in the area of the extruder screw. This eliminates the risk of dead spaces where residues can accumulate. REMBE® extruder rupture discs can also be fitted with an integrated signalling device (optional), which informs the process control system about the response of the rupture disc.

All standard connections/bores for pressure transducers or probes on plastic extruders can be fitted with REMBE® rupture discs.

### Applications

Autoclaves, LDPE (thermoplastic), food production

### Industries

Petrochemical, food, pharmaceutical industry

### Advantages

- ✓ **Maximum plant safety** and availability in models with signalling devices.
- ✓ **Compact unit** can be replaced quickly and easily.

Process medium	Suitability
Gas   Steam	✓✓
Liquid with gas cushion	✓✓
Liquids	✓
Two phase flow	✓
Hygienic applications	✓✓
✓✓ recommended	
✓ suitable	

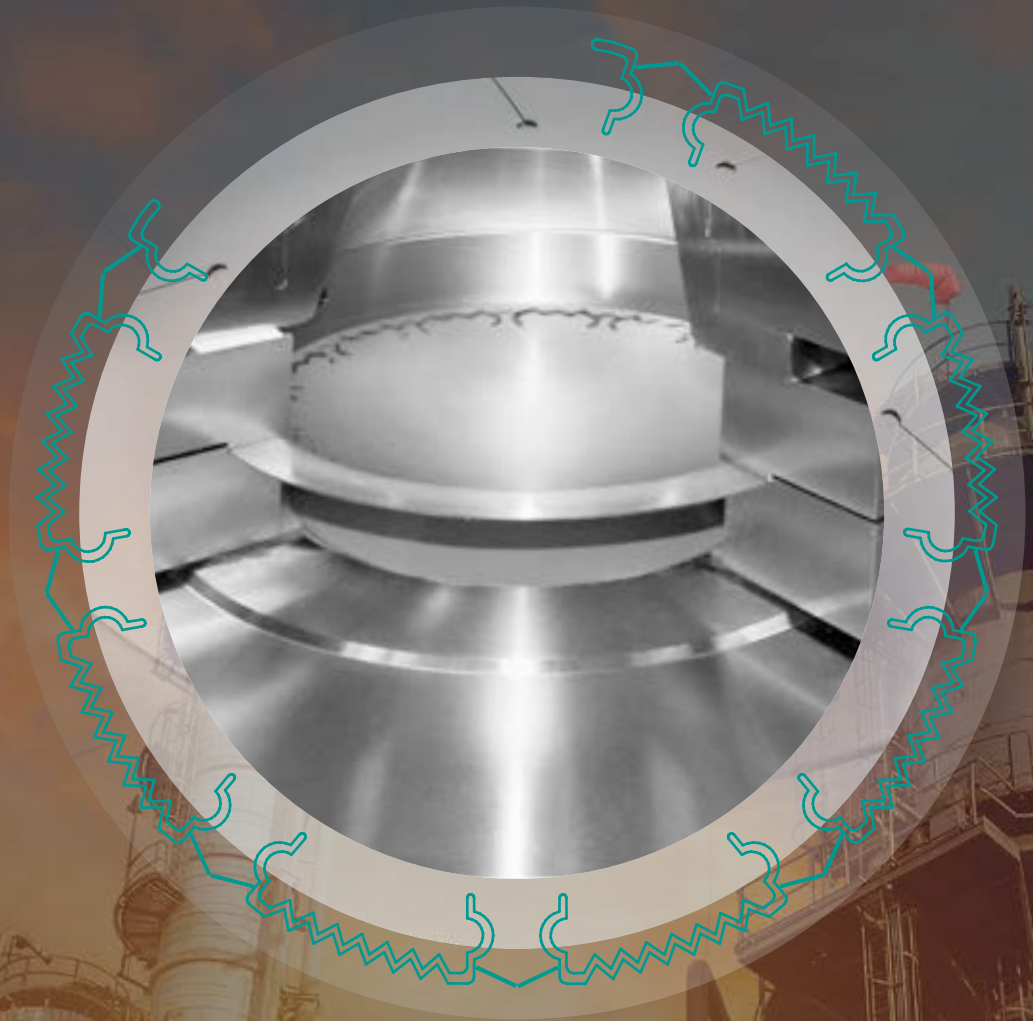

# Rupture Discs and Safety Valves

Rupture discs and safety valves can be combined in different configurations: The rupture disc can be installed below the safety valve or the two pressure relief systems installed in parallel.

In liquids, gases and two-phase media, a REMBE® rupture disc upstream from your safety valve simply saves you money.

## Advantages

- ✓ Improved leak-tightness for lower loss of media and long-term compliance with regulations and legal requirements.

- ✓ You can use safety valves made from lower cost materials even with corrosive, adhesive or polymerising media.
- ✓ Additional savings through in-situ tests.

If the systems are installed next to each other, the response pressure of the rupture disc is higher than that of the safety valve. If the rise in pressure is so large and rapid that the safety valve cannot respond sufficiently quickly or if it fails to open, the rupture disc serves as a reliable backup system to relieve the pressure. If the rupture disc is installed below the safety valve it can perform a number of roles:

## Improved leak-tightness

Even if your process does not involve toxic or very expensive media – safety equipment should still ideally be able to operate leak-free over long periods. Safety valves tend to leak more after being triggered for the first time. However, a REMBE® rupture disc positioned upstream of the safety valve ensures a perfect, leak-tight seal and saves you money. After all, it is cheaper to replace a rupture disc than a safety valve.

## Protection against "challenging" media

Every operator who has ever been in this position knows the problem: The functionality and reliability of some safety equipment is affected to a greater or lesser degree by corrosive, adhesive, polymerising or viscous media. This also applies to safety valves. If the valve seat is sticky, it is no longer possible to guarantee the defined response pressure.

This poses a risk even before the first time the safety valve is triggered. Cleaning and inspections are therefore essential to guarantee that – in the case of an emergency – the safety valve responds at the specified pressure.

A REMBE® rupture disc installed upstream protects the safety valve against caking and adhesions. Reverse acting rupture discs like KUB® have a smooth metal surface on the side facing the process, which prevents the build of deposits. Breaking points are isolated from the process. This ensures that the specified response pressure is maintained at all times and eliminates the possibility of a late response.

## In-situ testing of safety valves

Normally, safety valves have to be removed in order to test whether they are functioning correctly. This is time-consuming and expensive. However, in combination with REMBE® rupture discs, you can test your safety valves without moving them anywhere. To do this, the space between the rupture disc and the valve stroke is pressurised.

As KUB® has a back pressure resistance of 135 %, the rupture disc remains undamaged while the safety valve is being inspected. If in-house regulations nonetheless require the safety valve to be removed for inspection, the rupture disc can be left in position in a separate flange connection in order to close the opening while this work is being performed.



A relief valve secures the space between the rupture disc and the safety valve. Special safety valves and KUB® clean are used in hygienic applications.

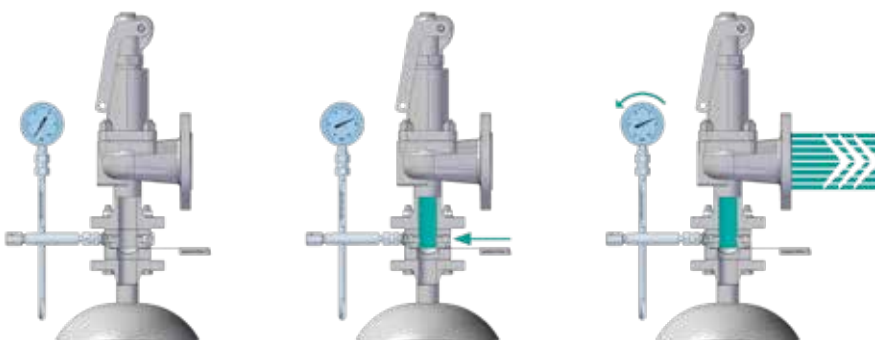

In-situ test: The space between the rupture disc and the safety valve is pressurised in order to test whether the safety valve is functioning correctly.





# Rupture Disc Holder for the perfect Installation.

REMBE® guarantees perfect installation and performance for your rupture disc. The various REMBE® rupture disc holders are specially designed to make it impossible to install the corresponding rupture discs incorrectly:

Rupture disc holders for KUB® and IKB® have a centring pin, which prevents the rupture disc being installed in the wrong position. In all other rupture disc holders, the differing internal diameters of the outlet and inlet

components ensure that the rupture discs are inserted properly.

## Advantages

- ✓ Easy to install torque independent designs.
- ✓ Full metal seal for excellent leak tightness.
- ✓ Its all standard flange sizes, customised designs available.
- ✓ Available in a wide range of materials.

**Holder**  
for triple-section  
rupture discs.

Reliable. German.  
Safety. ●●●●

The holder's unique design guarantees that the rupture disc is always inserted correctly. A full metal clamp ensures the seal is tight. This prevents the rupture disc from being damaged and allows it to be re-used after having been removed, e.g. during an inspection. The IG rupture disc holder features an inclined seat and is designed for forward acting rupture discs. The 30° oblique seating arrangement creates the optimum seal for the rupture disc ensuring leak tight integrity. The holder outlet has a slight radius to which the rupture disc is adapted. This guarantees the perfect fit of the rupture disc and maintains its optimal opening.

### Applications

Separators, autoclaves, chemical reactors, distillation towers, desalination plants, flare stacks, FPSOs, gas-tight pressure vessels, gas compressor modules, gas turbines for power generation, hazardous goods containers, geothermal energy, intermodal containers for corrosive/aggressive media, isolation of safety valves, condensers, power plants, cryogenic applications, cryostats + transport containers, LDPE (thermoplastic), food production, mixers, oil and gas separation and treatment, petrochemical plants, process vessels, refineries, reactors, spray dryers, sterile tanks, aseptic tanks, reverse osmosis systems, heat exchangers

### Industries

Breweries, petrochemical, food, oil and gas industry, aerospace, pharmaceutical industry, LNG

### Advantages

- ✓ **Full metal seal** for excellent leak tightness.
- ✓ **Easy to install.**
- ✓ **Its all standard flange sizes**, customised designs possible.
- ✓ **Available in a wide range of materials.**

**PTU holder**  
Pre-assembled holder  
for reverse rupture  
discs with integrated  
locating pin.

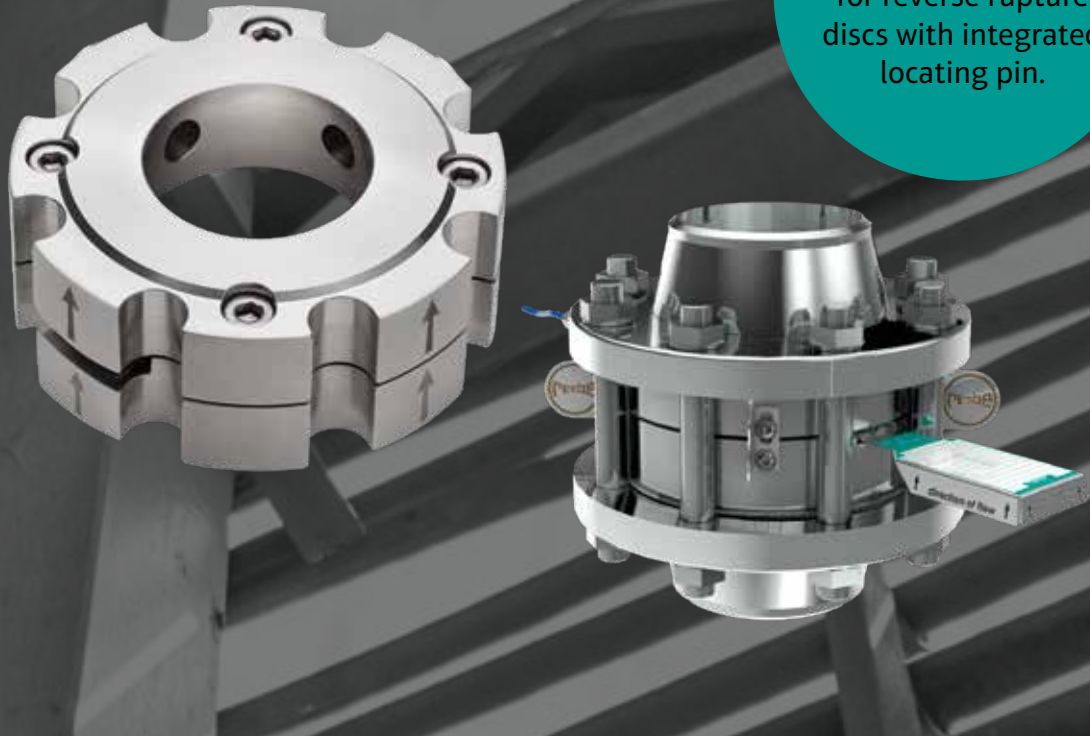

Reliable. German.  
Safety. ●●●●

The IG-KUB®-PTU rupture disc holder is a flat-seat holder for reverse acting rupture discs IKB® and KUB®.

The unique design of the IG-KUB®-PTU rupture disc holder always guarantees the proper insertion, and enables the pre-assembly of the rupture disc. This avoids a damaging of the rupture disc, which can then be reused after dismantling, for example, within the scope of an inspection.

The sealing edge of the seat surface ensures a leak-free sealing through a fully-metallic clamping. The inside diameter of the rupture disc holder outlet performs a support function and guarantees the optimal opening behaviour when the defined burst pressure is reached. The integrated pre-assembly bolts allow an easy and safe installation of the rupture disc. The holder can be used for a wide range of flanges and various pressure classes.

### Applications

Separators, autoclaves, chemical reactors, distillation towers, desalination plants, flare stacks, FPSOs, gas-tight pressure vessels, gas compressor modules, gas turbines for power generation, hazardous goods containers, geothermal energy, intermodal containers for corrosive/aggressive media, isolation of safety valves, condensers, power plants, cryogenic applications, cryostats + transport containers, LDPE (thermoplastic), food production, mixers, oil and gas separation and treatment, petrochemical plants, process vessels, refineries, reactors, spray dryers, sterile tanks, aseptic tanks, reverse osmosis systems, heat exchangers

### Industries

Breweries, petrochemical, food, oil and gas industry, aerospace, pharmaceutical industry, LNG

### Advantages

- ✓ **Pre-assembly of the rupture disc** for robust and safe handling with a defined torque.
- ✓ **Multi-flange design**, suitable for different pressure classes and flange systems.
- ✓ **High degree** of leak-tightness through a full-metal sealing.
- ✓ **Available in a wide range of materials.**
- ✓ Designs for different pressure ranges and companion flange types.
- ✓ Connection option for monitoring and excess flow valve units.
- ✓ **Reusable holder.**
- ✓ Metal-to-metal sealing.
- ✓ Standard materials: carbon steel, various stainless steels, hastelloy C, titanium, nickel, inconel.

**Double holder**  
for use with high or variable back pressures.

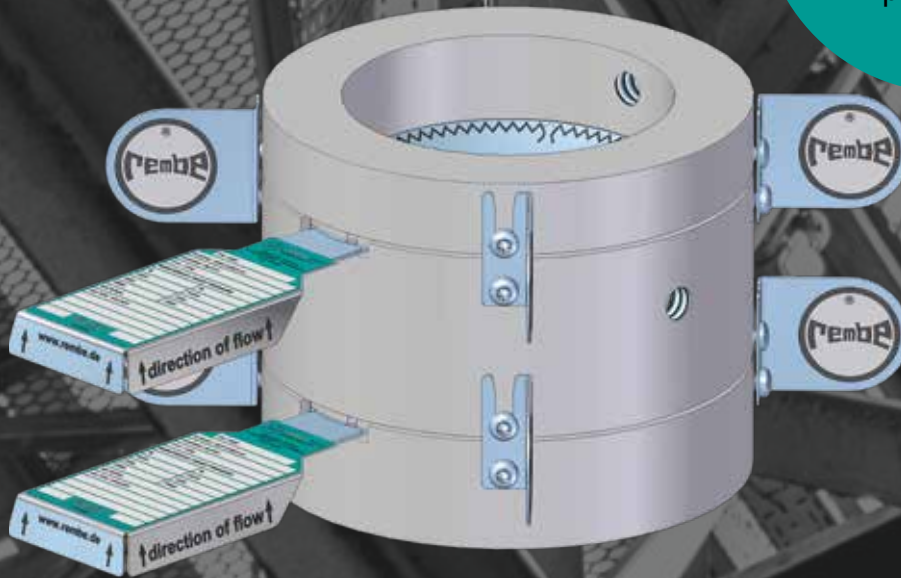

Reliable. German.  
Safety. ●●●●

Double disc assembly provide double the protection for production equipment working under extreme conditions, e.g. with highly corrosive, environmentally harmful or highly toxic substances. Both rupture discs in this unit burst in case of excessive pressure and thus protect the system. The area between these two discs is continuously monitored by a pressure measuring unit. If for instance corrosion, damage or any other factor leads to premature failure of the rupture disc on the system side, any leakage is detected by the pressure monitoring device between the two discs without the second downstream connected rupture disc reacting.

Another application for double rupture discs is the definitive initiation of a triggering/bursting operation. As an example, it is possible with two discs of differing bursting pressure to introduce pressure into the area between the discs. If the pressure is to be relieved, the evacuation of the intermediate area triggers a burst under system pressure.

The response pressures of the two discs depend on the operating conditions. Double disc assemblies are installed as insert units between welding neck flanges to DIN or ANSI standards. The flow direction must be observed during installation. All double disc assembly mounting units have pre-assembly bolts facilitating assembly to the rupture disc prior to installation in the pipeline or flange connection.

## Applications

Autoclaves, chemical reactors, Distillation columns, flare stacks, FPSOs, gas compressor modules, power plants, mixers, oil and gas separation and treatment, petrochemical plants, process vessels, refineries, reactors, heat exchangers

## Industries

Petrochemical, oil and gas industry, LNG

## Advantages

- ✓ **Increased protection for rupture discs** connected in series in processes/plants exposed to extreme conditions, such as highly corrosive, environmentally harmful or highly toxic media.
- ✓ **Supplied with pre-assembly screws** so that assembly with the rupture disc can take place before installation in the pipe.
- ✓ **User-friendly:** time-consuming pre-assembly, as with comparable designs, is not necessary.





**Heated/  
cooled holder**  
In applications with  
polymerising media.

Reliable. German.  
Safety. 

Rupture disc holders with integrated heating channels are specified for applications with polymerising media among others. This minimises the risks of product accumulation and adhesion. The holder is heated with warm liquids or gases. Alternatively, the same method can be used with refrigerants to cool the rupture disc holder.

### Applications

Chemical reactors, petrochemical plants, process vessels, refineries

### Industries

Petrochemical, oil and gas industry, pharmaceutical industry

### Advantages

- ✓ **No polymerisation or caking** on the rupture disc.
- ✓ **Temperature reduction** for longer service life of the rupture disc ensures less downtime.
- ✓ **Reduction of temperature changes** ensure a longer service life in operation.

## Threaded holder for small assembly groups.

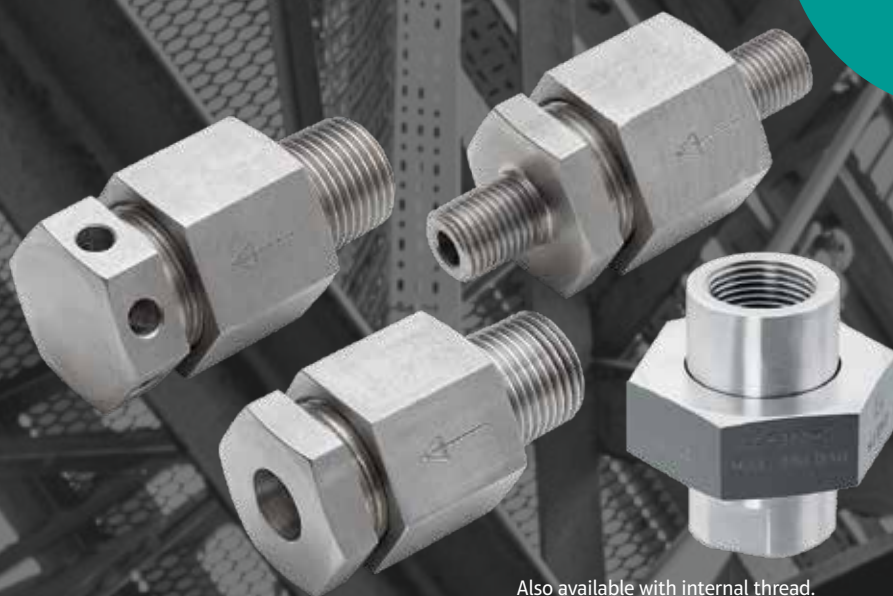

Reliable. German.  
Safety. ●●●●

Also available with internal thread.

REMBE® threaded holders DN 15-DN 25 are particularly suitable for securing smaller assembly groups such as autoclaves, pressure vessels, wind turbines, etc. In addition to the standard G or NPT threads, nearly all connections such as internal or UNF/UNC threads, pipe sockets or weld-on ends can be manufactured. In addition to stainless materials such as stainless steel grades, 304/304L, 316/316L, 316Ti, steel, brass or special alloys such as nickel, monel, titanium, hastelloy etc. are available. The threaded holders are suitable for holding forward acting rupture discs as well as triple-section rupture discs. Due to the design of the threaded holders, the tag plates are supplied loose. These must be attached to the outside of the fitting so that they are clearly visible. The U-type threaded holder is used in a space-saving way, especially in rigid piping systems.

### Applications

Separators, autoclaves, chemical reactors, desalination plants, gas-tight pressure vessels, gas compressor modules, intermodal containers for corrosive/aggressive media, isolation of safety valves, power plants, cryogenic applications, cryostats + transport containers, LDPE (thermoplastic), food production, mixers, oil and gas separation and treatment, petrochemical plants, process vessels, refineries, reverse osmosis systems, heat exchangers, water injection pumps

### Industries

Breweries, petrochemical, food, oil and gas industry, LNG

### Advantages

- ✓ **Standard threads and specific threads on customer request** (100% customised).
- ✓ **Easy replacement** of rupture disc and rupture disc holder.
- ✓ **High tightness and low leakage** due to adapted and appropriately designed sealing surfaces.
- ✓ **Reduced costs** due to replaceable rupture discs with equally high leak-tightness.

# Signalling devices for the optimal adaptation of the rupture disc to your requirements.

Automated processes use intelligent signalling systems to keep you informed at all times about the status of your entire plant and any faults that may arise. You can

even install signalling devices for rupture discs that have already been installed.

Reliable. German.  
Safety. 

## SK signalling

**Uses the principle of the closed circuit:** A signalling cable is integrated directly during the production of the rupture disc and thus forms a reliable unit with it. If the rupture disc opens, the signalling cable circuit is interrupted.

## SKK SGK signalling

**Also uses the principle of the intrinsically safe closed circuit:** Due to the adhesively fixed integral signalling, multiple installation positions are unnecessary. No additional requirements for tightness and installation height of the burst unit are necessary.

## SNR signalling

**With proximity sensor, for bi-directional acting rupture discs:** Specially developed for bi-directional acting rupture discs, also used for rupture discs with low response pressures. Thanks to the proximity switch, the signalling device offers inductive, intrinsically safe monitoring in accordance with NAMUR (EN 60947-5-6) and thus the highest safety standard.

## BIRD signalling

**With conducting path integrated in a ceramic element, also suitable for high temperatures:** The standard version withstands temperatures of up to 150°C, the high-temperature version even up to 400°C. Installation is done with a stainless steel bracket on the mounting frame.

## SLL signalling

**Uses infra-red beams with the help of an optical fibre:** When these from the transmitter of the SLL hit a reflector mounted on the rupture disc, they are registered by the receiver of the SLL. Both transmitter and receiver are integrated in the sensor head of the SLL. If the rupture disc opens, the reflection is interrupted and a signal is sent from the receiver of the SLL to the connected process control system.

## SB, SB-S, SBK-S signalling

**Uses the principle of the closed circuit, also available without vent hole:** The signalling membrane is installed directly between the flanges on the vent side of the rupture disc. When the rupture disc responds, the pressure of the outflowing process medium destroys the membrane and the intrinsically sealed closed circuit is interrupted, resulting in a fault message to the process control system.

## FOS signalling unit

**The fibre optic FOS rupture membrane is used to** monitor leakages and the response of rupture discs under highly corrosive conditions and in hazardous areas where electrical connections are not possible. The signalling element carries no current and consists of a glass fibre. When the rupture disc opens, the optical fibre circuit tears and the circuit is broken.



Reliable. German.  
Safety. ●●●

NIMU is a reusable, non-invasive detection system. After an overpressure event, and the associated opening of the rupture disc, the outlet part of the rupture disc holder must be removed, the rupture disc replaced, and afterwards the system can be put back into operation. The days when the signalling cables also had to be routed again to the respective junction box are finally over. Additionally: The process is absolutely leak-tight. The blind tapping in the holder replaces the tapping which is usually required. The absence of cable glands (required for the holder tapplings for conventional signalling cables) means that the cable glands used cannot become porous, thus preventing an escape of the process media.

### Applications

Separators, autoclaves, chemical reactors, distillation towers, desalination plants, flare stacks, FPSOs, gas-tight pressure vessels, gas compressor modules, gas turbines for power generation, hazardous goods containers, geothermal energy, intermodal containers for corrosive/aggressive media, isolation of safety valves, condensers, power plants, cryogenic applications, cryostats + transport containers, LDPE (thermoplastic), food production, mixers, oil and gas separation and treatment, petrochemical plants, process vessels, refineries, reactors, spray dryers, sterile tanks, aseptic tanks, reverse osmosis systems, heat exchangers, silos

### Industries

Breweries, petrochemical, food, oil and gas industry, aerospace, pharmaceutical industry, LNG

### Advantages

- ✓ **Totally leak tight process.**
- ✓ **Cost-effective signalling device.**
- ✓ **Full bore relief.**
- ✓ **Easy function testing and maintenance.**
- ✓ **Eliminates false alarms.**
- ✓ **Reusable.**

### Certification



ATEX  
EU-type examination certificate no.  
IBExU15ATEX1018

Reliable. German.  
Safety. ●●●



**ELEVENT®**  
protects vessel  
+ Tanks with low design  
pressures optimal  
against overpressure  
and vacuum.

Also available in hastelloy or with  
additional inert gas connection.

# Breather Valve: Convincing with a controlled pressure maintenance.

ELEVENT® not only prevents fugitive emissions of gas, or other pollutants, but also prevents the development of explosive mixtures of substances and eliminates the potential danger of air entering the system. ELEVENT® is used in the oil and gas industries, food processing, the chemical and pharmaceutical sectors and power plant technology.

The optimised "air cushion" sealing principle provides a smooth valve stroke and an extremely reliable leak-tight seal. This prevents abrasion and valve chatter. The metal housing is made from deep-drawn stainless steel.

## Applications

Separators, food production, mixers, oil and gas separation and treatment, petrochemical plants, process vessels, sterile tanks, aseptic tanks, silos

## Industries

Breweries, petrochemical, food, oil and gas industry, pharmaceutical industry, chemical industry

## Advantages

- ✓ **Overpressure and vacuum protection** with compact dimensions for extremely low pressure ranges from  $\pm 2$  mbarg.
- ✓ **Reliable leak-tight seal.**
- ✓ **Pressure setting can be subsequently changed.**
- ✓ **Suitable for applications with corrosive atmospheres** due to corrosion-resistant E-CTFE and PFA coating.
- ✓ **Quick and easy to install and service.**
- ✓ **Reduces nitrogen requirements** to a minimum for inerted processes.
- ✓ **Ideal for applications with high product purity and quality assurance requirements.**

Reliable. German.  
Safety. ●●●

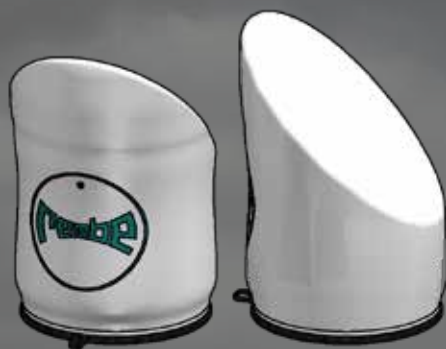

**REMBE® TEP**  
Tube-End-Protection-  
Protective cover  
for discharge pipes.

# TEP: Effective protection against weather and environmental influences.

Discharge piping can become clogged dirty or even blocked due to weather conditions such as rain or snow or environmental influences such as leaves, vegetation or bird/insect nests. This creates an incalculable risk for the process to be protected. Effective pressure relief is no longer guaranteed in an emergency. REMBE® Tube-End-Protection effectively protects the open end of the discharge pipe against weather and environmental influences.

The protective cover made of breathable, robust and waterproof PE fleece adapts perfectly to the discharge pipe due to the integrated elastic band. A 45° bevel allows rainwater to run off and prevents pooling. When a safety device is activated and releases into the discharge pipe, the TEP detaches from the pipe and tears apart with minimal fragmentation as it flies away. The optional retrieval rope set, consisting of a 3 m expander rope, carabiner and 2 rope clamps, minimises the risk of any parts of the TEP flying away uncontrollably during disc opening. The retrieval rope set is reusable and does not need to be demounted after activation of the safety device.

Additionally: The breathable material prevents pressure build-up in the pipe and the space between the safety device and the protective cover always remains depressurised. A positive side effect: condensation is minimised.

## Advantages

- ✓ Effective protection against weather and environmental influences
- ✓ Cost-efficient due to quick and easy installation
- ✓ PE fleece – no perfluorinated and polyfluorinated alkyl substances (PFAS)
- ✓ Visual detection when a safety device responds
- ✓ Breathable – prevents pressure build-up and minimises condensation
- ✓ 100 % recyclable material

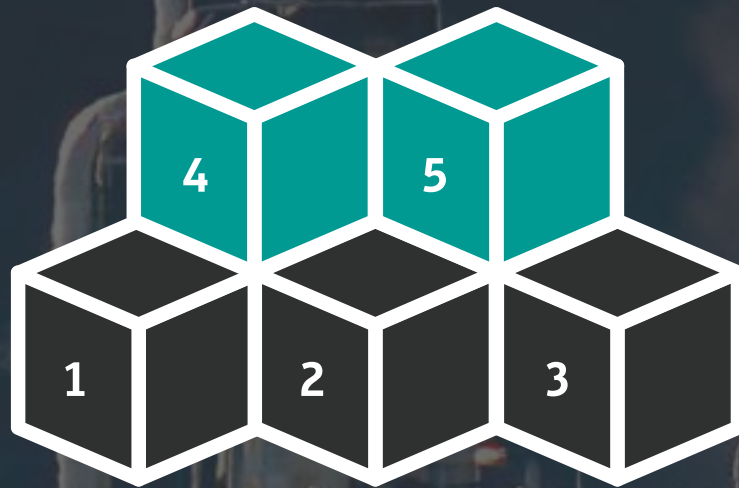

# REMBE® Safetyneering

## 5 Elements for maximum safety.

In total REMBE® Safetyneering provides companies with five elements, supporting them with the implementation of their safety goals. From the overall consideration of a safety management system, through the execution of process hazard analyses and semi-quantitative risk determinations, to the revalidation and testing of the design of protection layers, a complete package is offered that can help to significantly improve the process safety of plants.

- 1 | **Process Safety Management (PSM)** Support for the implementation and maintenance of a process safety management system.
- 2 | **Prozess Hazard Analyses** Support with the implementation of process hazard analyses.

- 3 | **LOPA (Layers of Protection Analysis)** Support with the implementation of LOPAs (Layers of Protection Analyses) for the semi-quantitative risk determination of potential worst case scenarios.
- 4 | **Protection against Hazards from Plants with increased Potential for Risk** Support with the establishment of a company network with the goal of providing optimum protection to plants with a high potential for risk. (We may also offer audits with a specific focus on those plants.)
- 5 | **Evaluation of Layers of Protection** Support with the design evaluation of layers of protection, particularly emergency relief systems and electronic safety interlocks.

Contact us!

To get more detailed information about the other REMBE® Safetyneering elements, please visit <https://rembe.de/service/rembe-safetyneering>.



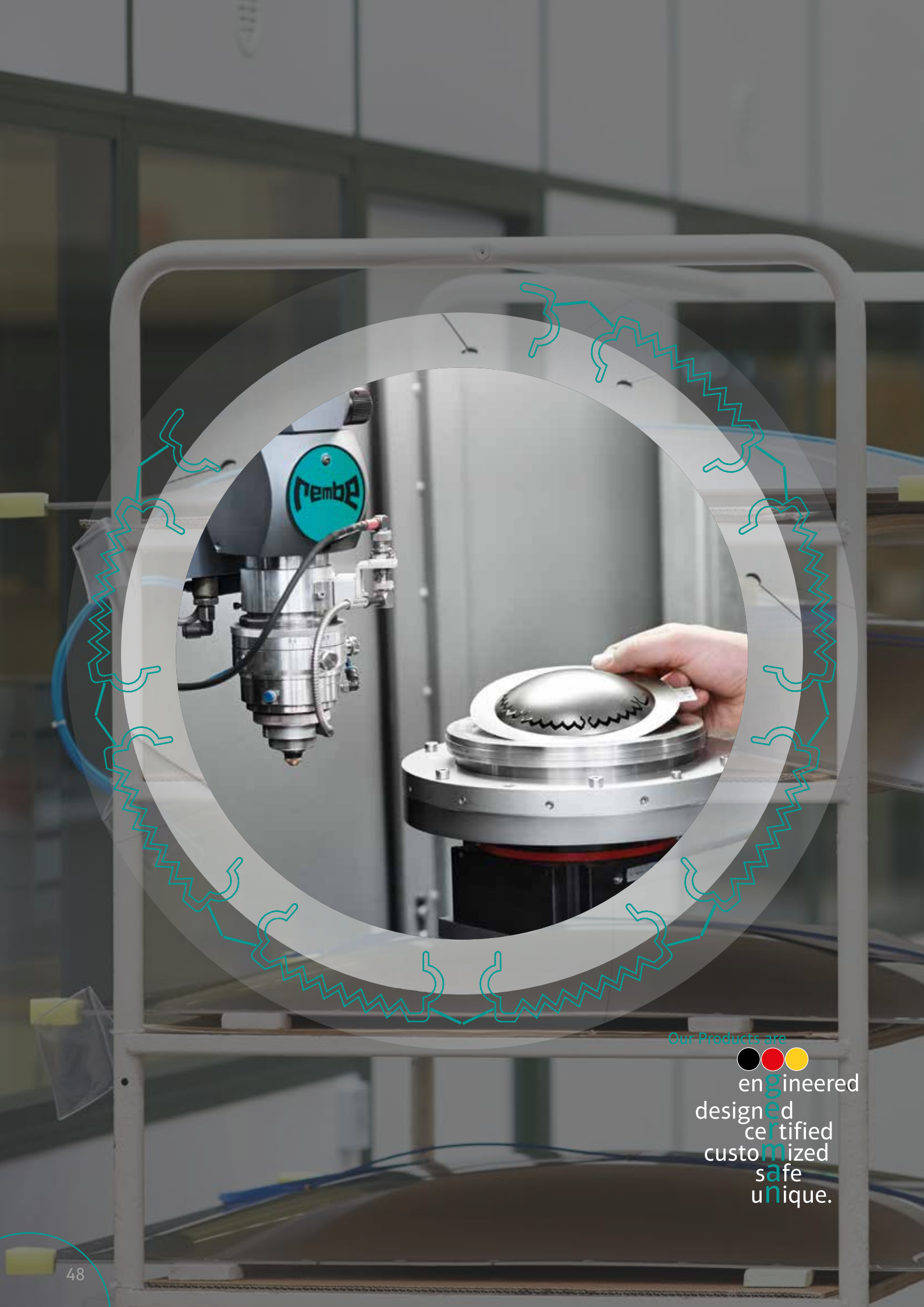

Our Products are

  
 engineered  
 designed  
 certified  
 customized  
 safe  
 unique.



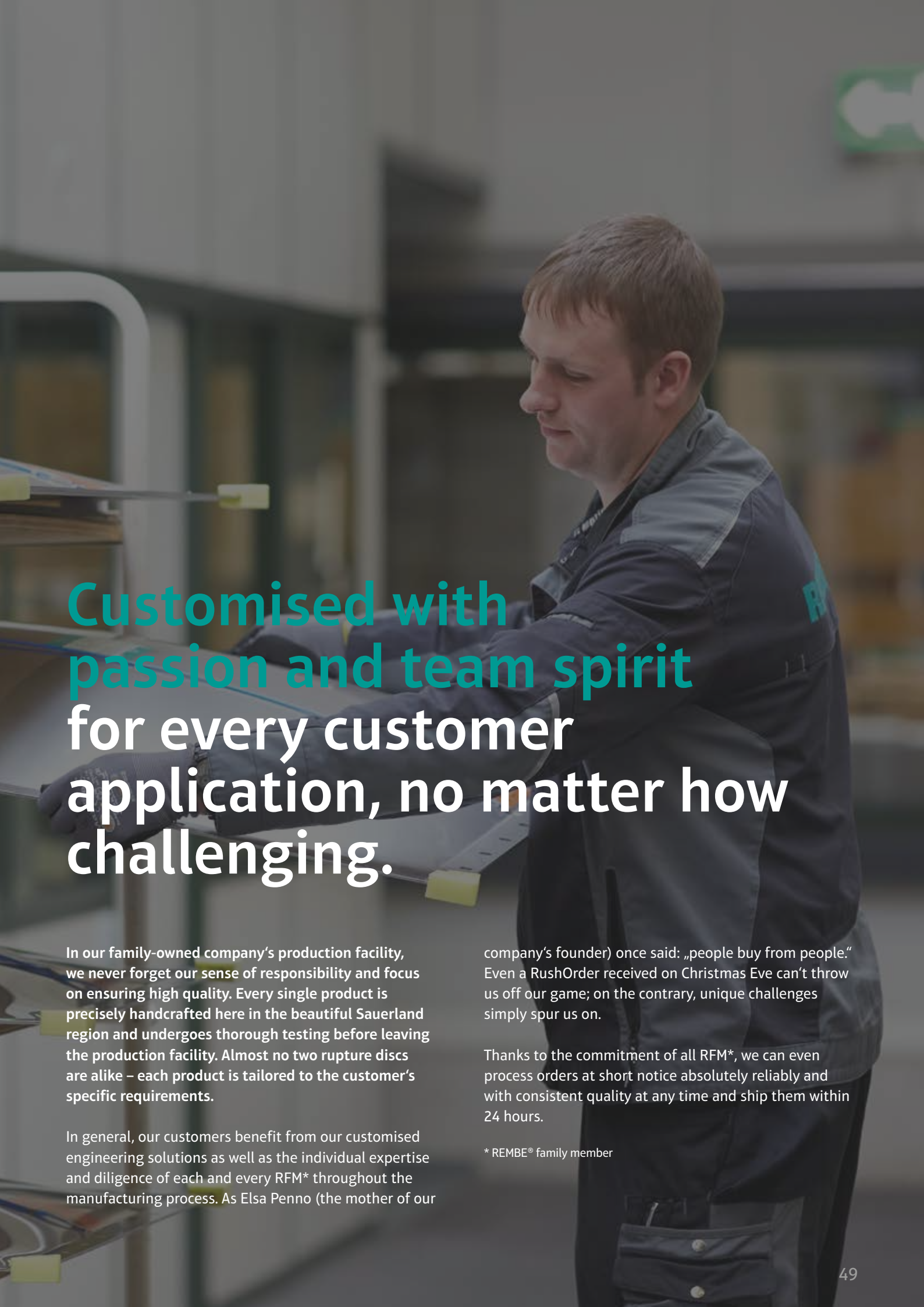

# Customised with passion and team spirit for every customer application, no matter how challenging.

In our family-owned company's production facility, we never forget our sense of responsibility and focus on ensuring high quality. Every single product is precisely handcrafted here in the beautiful Sauerland region and undergoes thorough testing before leaving the production facility. Almost no two rupture discs are alike – each product is tailored to the customer's specific requirements.

In general, our customers benefit from our customised engineering solutions as well as the individual expertise and diligence of each and every RFM\* throughout the manufacturing process. As Elsa Penno (the mother of our

company's founder) once said: „people buy from people.“ Even a RushOrder received on Christmas Eve can't throw us off our game; on the contrary, unique challenges simply spur us on.

Thanks to the commitment of all RFM\*, we can even process orders at short notice absolutely reliably and with consistent quality at any time and ship them within 24 hours.

\* REMBE® family member



Safety is for life.™

# Operational safety 5.0 is a huge responsibility. It is a task to which we have dedicated ourselves with unwavering commitment since 1973.

Our specialists pursue only one goal worldwide: the optimal protection of your plants and processes. You thus benefit from our decades of experience, which enable us to guarantee an honest risk analysis and high-quality products. With due care and responsibility, we focus on optimising your individual processes, production systems and products.

Choosing REMBE® means choosing seamless complete safety.

As an independent German medium-sized company, we can offer you products that are engineered in Germany for added safety. In addition, our experts in Process Safety and Explosion Safety are always ready to assist you: 365 days a year, 24 hours a day.

That's our promise.

## Consulting

We don't just work at our desks.

We also work on your premises.

Each production facility is different and has different requirements. This is why our experts have a close look at your entire plant with you to determine what's genuinely reasonable and what will be the best solution for you.

It's your perfect investment in safety.

Solutions off-the-peg? Not from REMBE®.

Once we've looked at all the relevant documents, we will identify all the existing space for improvement and create a profitable safety policy for you that is perfectly geared to suit your company.

## Engineering

We don't just make recommendations.

We give you the best solution.

From the paper to production: you will have a safety system that is perfectly tailored to suit your processes and operational requirements.

Whether it's explosion safety or pressure relief, our engineering ensures that you get the best solution at all times – made in Germany.

## Products

Our products are not just excellent.

They are approved and certified.

Good is never good enough for us. And so we keep putting ourselves on the test bench. The result is safety products licensed under globally recognised and industry-specific standards and regulations.

Moreover, we are the first company worldwide to offer SIL-equivalent parameters for mechanical (flameless) explosion venting products and the relevant signallers. This high quality standard makes perfect economic sense for you. Our extensive product range ensures that you always receive the most cost-effective and reliable solution for your needs. We take responsibility for the big picture. With us you get everything from a single source, thus ensuring good profitability and legal security.

## Service

Downtime cost money.

Our service never stands still – throughout the world.

REMBE® archives all production documents.

All REMBE® rupture discs have a 7-digit serial/batch number. That's why, even decades later, we are able to identify your rupture disc within a short space of time and produce parts with exactly the same specification. Please keep this serial/batch number ready when you have a request for spare parts.

If you're ever in a hurry, why not use our Rush Order Service? We can guarantee that you're given the highest priority and that your product is made straight away. Depending on the destination, we'll deliver within less than 24 hours. This also applies to spares, additional items and custom designs. REMBE® speaks your language. Our global network of offices and our many international experts can guarantee that we always understand you and your needs. Just give us a ring.



# Complete solutions with real added value: **REMBE® CAE**

REMBE® is constantly expanding its portfolio of products and services. CAE services are the latest addition within consulting and engineering. Until now, customers had to commission strength verifications, tightness analyses or temperature curves from separate engineering offices. That's over now.

REMBE® is the first company of its kind to offer CAE services that, in combination with the company's high-quality products, provide the customer with a complete solution with real added value: Lower costs and the implementation of the calculations by specialists in explosion protection and pressure relief guarantee the most reliable results.

## Strength verifications

Guidelines: AD 2000 Merkblatt, FKM guideline, DIN EN 14460:2018-04

In addition to analyses of our own products, we can also take into account other plant elements such as pipelines and vessels (tanks, filters, ...) of the customer, analyse them and illustrate to the customer how the elements under consideration perform under different (operating) conditions. This gives the customer a reliable assessment already in the planning phase, which they can use for further action. This saves the customer costs for real tests with test constructions or expenses caused by incorrect configurations.

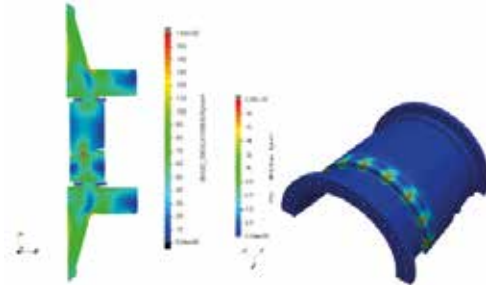

## Installation torque calculations

Guidelines: VDI 2290, TA Luft

There are generally different approaches when it comes to selecting the required installation torque. Alongside manufacturer information for individual components, there are calculation standards such as DIN EN 1591-1 or the AD 2000 Merkblatt, with which conventional flange systems can be calculated analytically. In practice it is more common for a flange system to be expanded by additional components. This can be a pressure protection mechanism, such as a rupture disc. The conventional calculation standards are not valid for these expanded flange systems, as the equations on which these standards are based do not take any other components into account. By using the finite element method, the installation torque can also be carried out for expanded flange systems.

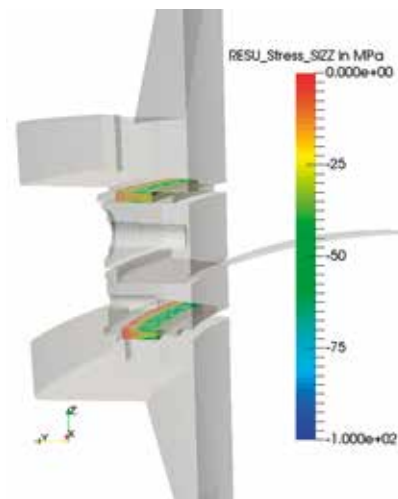

## Response Spectrum Analysis

Guidelines: Technical rules according to KTA

In many applications, the stability of installations must be investigated due to long-lasting excitations (e.g. earthquake loads, wind or wave loads, vibrations, etc.). For the calculation, a modal analysis is first performed and this is combined with a known response spectrum. Then the maximum stresses and displacements can be evaluated.

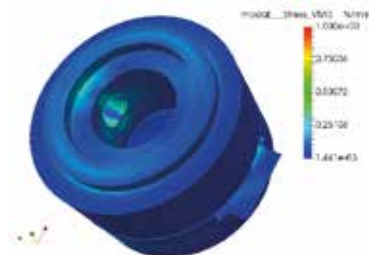

## Quality

Our products are manufactured according to the latest, up-to-date international standards for management systems, pressure equipment and explosion safety devices. As well as prioritising quality and reliability, we attach major importance to eco-friendly technologies, manufacturing processes and compliance with standards. High-quality materials from controlled sources ensure that our products have exceptionally long lifetimes.

## Certifications

### Management systems

DIN EN ISO 9001:2015, KTA 1401,  
DIN EN ISO 14001:2015, DIN ISO 45001:2018

### Products

RL 2014/68/EU (PED), ASME Sec. VIII, Div. 1, China Manufacture License, KOSHA (South Korea), TR ZU 010/2011, TR ZU 032/2013, RL 2014/34/EU (ATEX), IECEx, RL 2010/35/EU (TPED), TR ZU 004/2011, TR ZU 012/2011, TR ZU 020/2011, FM Global, GL, EHEDG

### Testing standards

AD 2000-Merkblatt A1, EN ISO 4126-2, DIN EN 1127-1 /-13463/-14373/-14491/-14797/-14994/-15233/-16009/-16447, EN IEC 60079-0/-60079-11/-60079-31, VDI 3673, NFPA 68, NFPA 69, IEC 61508

### Approval of German Aviation Authorities

Known Consignor (DE/KC/00912-01 + DE/KC/00912-02)

### Approval of German Customs Authorities

AEO CS – Customs Simplifications/Security and Safety (DE AEOF 126130)



# Sustainability

**Bhopal, Chernobyl, Seveso, Fukushima Are synonyms for environmental catastrophes of past decades in the industry – with devastating consequences for man and nature. They could have all been avoided with reliable safety technology.**

REMBE®'s rupture discs and explosion protection systems safeguard processes in all industries worldwide and contribute every day to making this planet safer.

We not only provide professional protection for your plant and machinery and protect human lives, but also avoid harmful emissions sustainably eliminate leaks and/or reduce leakages and/or reduce noise pollution.

All REMBE® products meet the requirements for environmental protection through reducing emissions.

We at REMBE® achieve maximum impact in terms of environmental protection by doing even more intensively and sustainably what we have been implementing

successfully since 1973: Developing and producing protection systems for industry.

We only offer you a technically worthwhile, economic and sustainable solution for your application. Our objective is to produce even more sustainably. Certification according to DIN EN ISO 14001:2015 as well as environmental projects that we promote within the framework of the REMBE® green initiative demonstrate our commitment to more sustainability.

Visit [rembe-green.de](http://rembe-green.de) and learn more about all projects.



[rembe-green.de](http://rembe-green.de)

# Globally local: The **REMBE**<sup>®</sup> locations.

We have founded a number of companies around the world to provide you with local service. **REMBE**<sup>®</sup> is represented in more than 80 countries globally by well-known and long-standing partners.

Find the representative responsible for your country at:  
T + 49 2961 7405-0,  
hello@rembe.de or www.rembe.de.

**REMBE**<sup>®</sup> GmbH Safety+Control  
Gallbergweg 21  
59929 Brilon, Germany  
T +49 2961 7405-0  
hello@rembe.de

**REMBE**<sup>®</sup> Asia Pacific Pte. Ltd.  
140 Paya Lebar Road  
#07-13 AZ@Paya Lebar  
Singapore 409015, Singapore  
T +65 6702 3707  
hello@rembe.sg

Representative Office Thailand:  
30, Soi Sukhumvit 61  
Khwaeng Khlong Tan Nuea  
Khet Watthana, Bangkok,  
Thailand 10110  
T +65 6702 3707  
hello@rembe.sg

**REMBE**<sup>®</sup> América Latina Ltda.  
Rua São Bento, 1859 – Hauer  
81630-230 Curitiba PR, Brazil  
T +55 41 3099 7699  
hello@rembe-lat.com

**REMBE**<sup>®</sup> China Ltd.  
World Plaza 30I/No. 855 Pudong  
South Road  
200120 Shanghai, China  
T +86 21 33829869  
hello@rembe.cn

**REMBE**<sup>®</sup> GmbH Safety+Control  
(DMCC Branch)  
DMCC Business Centre  
Jewellery & Gemplex Building  
Building 3, 1st floor Unit  
No. 30-01-1891  
Dubai, United Arab Emirates  
T +49 162 2702871  
james.hay@rembe.ae

**REMBE**<sup>®</sup> Inc.  
9567 Yarborough Rd.  
Fort Mill, SC 29707, USA  
T +1 704 716 7022  
hello@rembe.us

**REMBE**<sup>®</sup> K.K.  
Level 10 Hulin Minatomirai,  
1-1-7 Sakuragi-cho, Naka-ku  
231-0062 Yokohama, Kanagawa,  
Japan  
T +81 (0)45 228 5460  
hello@rembe.jp

**REMBE**<sup>®</sup> Oy  
Hitsaajankatu 4C  
FI-00810 Helsinki, Finland  
T +358 10 6662343  
hello@rembe.fi

**REMBE**<sup>®</sup> S.r.l.  
Via Maja, 2  
21051 Arcisate (VA), Italy  
T +39 0332 476511  
hello@rembe.it

**REMBE**<sup>®</sup> ZA  
20 Libertas Road  
Freeway Park  
Boksburg 1459, South Africa  
T +27 011 9162807  
hello@rembe.co.za



Safety is for life.™

## Consulting. Engineering. Products. Service.

The copyright for all content (design, text, pictures, graphics etc.) is the sole property of REMBE® GmbH Safety + Control except where otherwise stated. Reproduction and publication in whatever format, even in part, are strictly prohibited and require our explicit written approval. The specifications, figures and drawings published in our brochures reflect our current understanding of these products. However, they do not represent a binding guarantee of these properties. REMBE® reserves the right to make technical changes or update any information without notice. REMBE® accepts no liability for errors or omissions, technical changes due to research and development or errors in the printing or use of this brochure. It is the sole responsibility of the end user/ plant operator to ensure that REMBE® products are used correctly.



**REMBE® GmbH Safety+Control**

Gallbergweg 21 | 59929 Brilon, Germany

T +49 2961 7405-0

hello@rembe.de

